

user's guide

A large, faded, grayscale background image of a person wearing a hat and sunglasses, holding a camera up to their eye as if taking a picture. The person is positioned in the center-left of the page.

AATON

The XTRplus User Guide

Peter Abel

Abel Cine Tech Inc.
66 Willow Avenue
Staten Island, NY 10305
(718)273-8108
(718)273-8137 fax

© January 1995 Abel Cine Tech Inc.

All rights reserved. No part of this manual may be reproduced or transmitted in any form or by any means, electronic, mechanical, photocopying, recording, or otherwise, without the prior written permission of the publisher. For more information contact Abel Cine Tech.

Notice of Liability

The information in this manual is distributed without warranty. While every precaution has been taken in the preparation of this manual, neither the author nor Abel Cine Tech Inc. shall have any liability, loss, or damage caused or alleged to be caused directly or indirectly by the instructions contained in this manual or by the equipment described herein.

Trademarks

AatonCode, Keylink, OriginCplus, XTRplus, XTRprod, and X0plus are registered trademarks of Aaton Cameras Inc. / Grenoble, France.

Front View.....	10
Rear View.....	11
Battery Side.....	12
Motor Side.....	13
LCD Control Panel - Quick Reference.....	14
LED Indicators - Quick Reference.....	14

1. Lenses.....	16
Aaton Lens Port.....	16
Installing the Lens.....	16
ArriPL Lens Port.....	17
2. Viewing System.....	17
Viewfinder Options.....	17
Attaching the Extension Finder.....	18
Viewfinder Tension Adjustments.....	18
Adjusting the Diopter.....	19
The Eyepiece Shutter.....	19
Adjusting the Viewing Horizon.....	20
Viewing Screen.....	20
3. Mirror Shutter.....	21
4. Film Gate and Pulldown Claw.....	22
Co-planar Movement.....	22
The Hair-free Gate.....	22
Cleaning the Gate.....	23
5. Magazine.....	23
Installing the Magazine.....	23
Removing the Magazine.....	24
6. Power.....	24
Installing the Battery on the Camera.....	25
Battery Charging.....	25
Other Power Options.....	25
7. Motor.....	26
Camera Speeds.....	26
Using an External Speed Control.....	26
Electronic Inching.....	27
Single Frame Operation.....	28

8. ASA Setting	28
9. Lightmeter	28
Display.....	29
Operation.....	29
Using the Lightmeter without Running Film.....	29
Testing and Adjusting the Meter.....	30
Turning the Lightmeter Off.....	31
10. AatonCode	31
11. LCD Control Panel	32
AatonCode.....	32
ASA Setting.....	32
Battery Voltage.....	32
Camera Speed.....	33
Footage Remaining.....	33
Feet or Meters.....	33
Software Version.....	33
12. LED Indicators	34
Camera Test Indicator.....	34
Camera Run Indicator.....	34
Low Battery Indicator.....	34
End-of-Film Warning Sequence.....	34
13. Connectors	35
XLR4 - Power In.....	35
Amph9 - Accessory Input.....	35
Lemo14 - CCD Assist.....	35
Lemo6 - Accessory Input.....	35
Lemo2 - On/Off Input.....	36
Lemo5 - Timecode Input.....	36
14. CCD Assists	36
Installing the Control Units.....	36
The Internal Beamsplitter.....	37
Positioning the Beamsplitter.....	38
The Beamsplitter Axis Adjustment.....	39
The Manual Iris.....	39
Battery Life with CCD Assist.....	39
Installing the CCD Heads.....	40

1. Lens	60
Lens Elements.....	60
Lens Exterior.....	60
Mounting Surface.....	60
2. Body	60
Exterior.....	60
Mounting Surfaces.....	60
Camera Gate.....	61
3. Viewing System	61
Viewing Screen / Exterior Surface.....	61
Eyepiece.....	62
Viewfinder.....	62
Viewing Screen / Interior Surface.....	62
4. Magazine	64
Exterior.....	64
Pressure Plates.....	64
Interior / Film Path.....	64

SUPER16

1. Super16	66
The Format.....	66
When to Shoot Super16.....	66
2. General Concerns	66
Protecting the Negative.....	66
Maintaining High Quality.....	67
Super16 Compatible Lenses.....	68
Ordering Film.....	68
Film Processing.....	69
3. Shooting Super16	69
Selecting a Film Stock.....	69
Lenses.....	69
Lighting.....	69
Exposure.....	70
Camera Moves.....	70
4. Super16 Field Conversions	70
Before You Begin.....	71
Procedure.....	72

VII**AATONCODE**

1. Concept	82
2. The Internal Clock	82
3. Origin <i>Cplus</i>	83
4. Initializing AatonCode in the Camera	83
Using the Origin <i>Cplus</i> - Recommended Method.....	84
Using an External SMPTE Device.....	84
5. Monitoring and Maintaining AatonCode	85
Monitoring AatonCode with Origin <i>Cplus</i>	85
Maintaining AatonCode without Origin <i>Cplus</i>	86
6. The Camera Assistant's Duties	86
Checking the Diodes.....	86
Setting the ASA.....	87
Checking for Running Time.....	87
7. Recommended Film / Audio Selections	87

VIII**TECHNICAL SPECIFICATIONS**

List of Specifications.....	90
Connector Pin Attributions.....	92

IX**WORLDWIDE SUPPORT**

List of Agents.....	94
---------------------	----

System Features and Controls



© 2017 Intel Corporation

1001

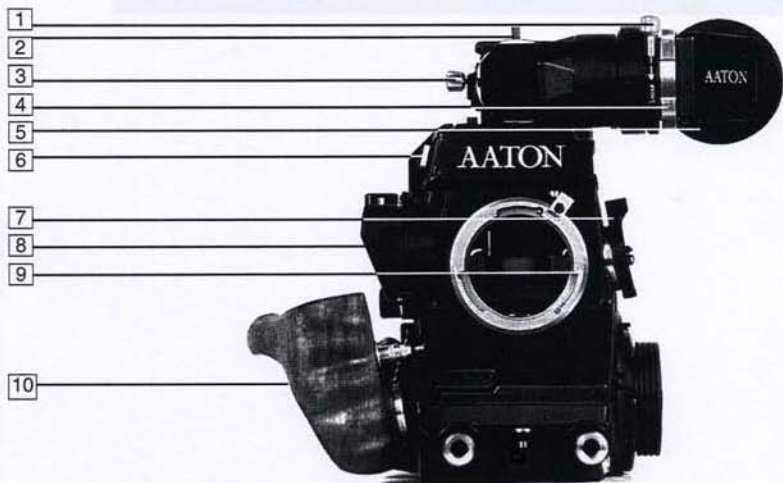

Front

1 - Friction Adjusting Ring	adjusts the tension of the eyepiece swivel.
2 - Tape Measure Stud	holds tape measure at film plane.
3 - Lateral Lock Knob	locks the lateral position of the viewfinder.
4 - Eyepiece Lock Ring	fastens interchangeable standard and extension finders.
5 - Eyepiece Shutter	blocks light when operator's eye is away from the finder.
6 - Beamsplitter Access Cap	covers the port which accesses the beamsplitter adjustment screw.
7 - Body Run/Test Switch	provides camera run and half frame inching.
8 - CCD Cover	accesses the CCD head.
9 - Aaton Lens Port	standard mounting system for XTR <i>plus</i> .
10 - Wooden Handgrip	allows for comfortable handheld operation.

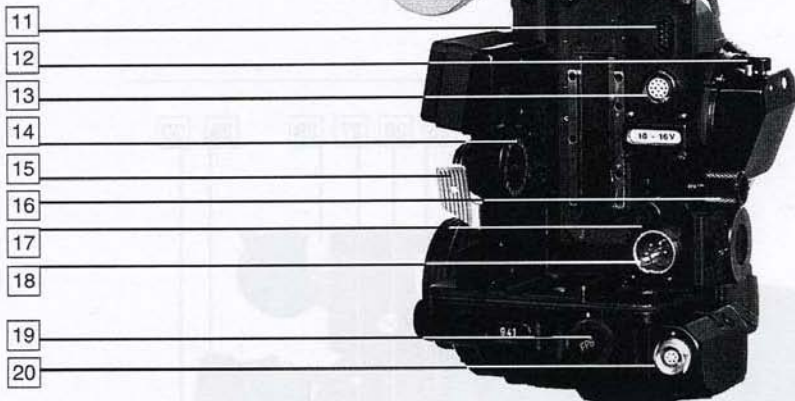

Rear

- | | |
|--------------------------------|--|
| 11 - Amph9 | accessory input provides +/-, Hz, and camera run functions. |
| 12 - Manual Iris Lever | controls CCD iris operation. |
| 13 - Lemo14 | connects CCD head to the CCD control unit. |
| 14 - Magnetic Drive | provides magnetic magazine coupling. |
| 15 - Mag Release Lever | releases the magazine for removal. |
| 16 - Battery Lock Screw | fastens the on-board battery to the camera body. |
| 17 - Camera Fuse | protects the body from excessive current and reverse polarity. |
| 18 - XLR4 | main power input for on-board battery or other 12V power source. |
| 19 - Speed Dial | adjusts the crystal sync speeds of the body. |
| 20 - Lemo6 | accessory input provides +/- and camera run functions. |

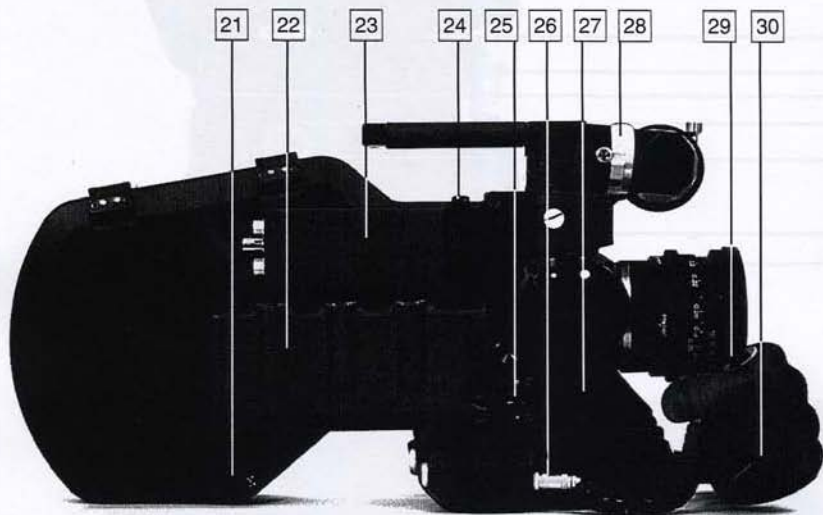

Battery Side

- | | |
|-------------------------------|--|
| 21 - Take-up Latch | locks the magazine take-up door. |
| 22 - On-board Battery | 12V nicad for handheld operation. |
| 23 - CCD Control Unit | fastens to the body for CCD operation. |
| 24 - CCD On/Off | powers the CCD assist. Switch off to conserve battery life. |
| 25 - LED Indicators | battery side indicators for camera run, camera test and low battery. |
| 26 - Lemo2 | input provides camera run functions. |
| 27 - Desiccative Cap | holds silica gel caplet for moist and humid situations. |
| 28 - Diopter Set Ring | adjusts the diopter setting of the viewfinder to the operator's eye. |
| 29 - Handgrip Run/Test Switch | provides camera run and full frame inching from the handgrip. |
| 30 - Handgrip Adjusting Screw | adjusts the rotation of the handgrip. |

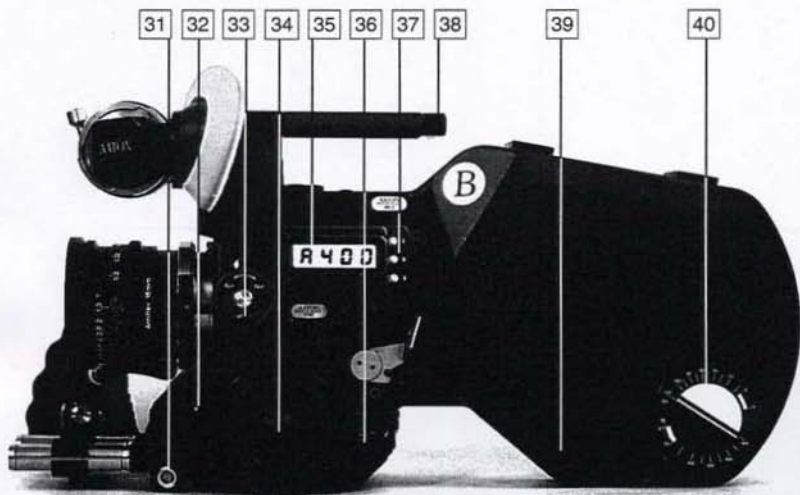

Motor Side

- | | |
|--------------------------|--|
| 31 - Lemo5 | AatonCode and SMPTE timecode communication. |
| 32 - Lightmeter On/Off | activates the lightmeter display in the viewfinder. |
| 33 - LED Indicators | motor side indicators for camera run, camera test and low battery. |
| 34 - Motor | triphase salarium, low power consumption. 3-75 fps operation. |
| 35 - LCD Display | indicates AatonCode, ASA, speed, voltage, mag ID, footage. |
| 36 - ASA Dial | adjusts the internal ASA setting for lightmeter and timecode matrix. |
| 37 - Display Buttons | access information from the control panel. |
| 38 - Carrying Handle | includes tape measure stud and 3/8-16 accessory screw. |
| 39 - Feed Latch | locks the magazine feed door. |
| 40 - Mag Footage Counter | displays the footage remaining in the magazine feed side. |

CD Control Panel - Quick Reference

Desired Function	Body Configuration	What To Do
Show AatonCode	Time initialized, mag on or off camera	Default mode; automatically displayed when camera is not running
Count remaining footage	Mag on camera	Set on/off switch to Run or Test
Count in feet or meters	Mag on camera	Press all three buttons simultaneously
Reset footage - full load	Mag on camera	Press buttons 1 & 3 simultaneously
Reset footage - short end	Mag on camera	Press buttons 1 & 2 simultaneously
Show ASA knob setting	Mag off camera	Set on/off switch to Test position
Read battery voltage	Mag on or off camera	Press button 3
Read camera speed	Mag on or off camera	Set on/off switch to Run position, Press button 2
Show AatonCode software	Mag on or off camera	Set on/off switch to Test position, Press button 2

ED Indicators - Quick Reference

Status	Indicator	Where to Find
Camera Test	Blinking red diode, (long on, short off)	Left and right outside of body and in the viewfinder
Camera Run	Solid yellow diode only; Lightmeter flashes once per foot/meter	left and right outside of body; In the viewfinder
Low battery	Flashing red diode, (same duration on, off)	Left and right outside of body and in the viewfinder
Pre end-of-film (30 feet remaining and less)	Faster flashing lightmeter display, (2-3 times / second)	In the viewfinder, (if lightmeter is turned on)
End-of-film	Alternately flashing display	In the viewfinder, (with lightmeter on or off)



The Camera Body

What's New in 2004

The camera body is the heart of the camera system. It's the part that houses the lens, the shutter, the viewfinder, and the controls. In 2004, camera manufacturers are focusing on making the camera body more compact and more user-friendly. This means that the camera body is becoming more of a "point-and-shoot" camera, rather than a "serious" camera. This is a good thing, because it makes the camera more accessible to a wider range of people. The camera body is also becoming more of a "digital" camera, rather than an "analog" camera. This means that the camera body is becoming more of a "digital" camera, rather than an "analog" camera. This is a good thing, because it makes the camera more accessible to a wider range of people.

What's to Watch for

As the camera body becomes more compact and more user-friendly, it's important to watch for a few things. First, the camera body should be able to handle a wide range of lenses. This means that the camera body should be able to handle lenses that are both wide-angle and telephoto. Second, the camera body should be able to handle a wide range of shutter speeds. This means that the camera body should be able to handle shutter speeds that are both fast and slow. Third, the camera body should be able to handle a wide range of ISO speeds. This means that the camera body should be able to handle ISO speeds that are both high and low. Finally, the camera body should be able to handle a wide range of lighting conditions. This means that the camera body should be able to handle both bright and dark lighting conditions.

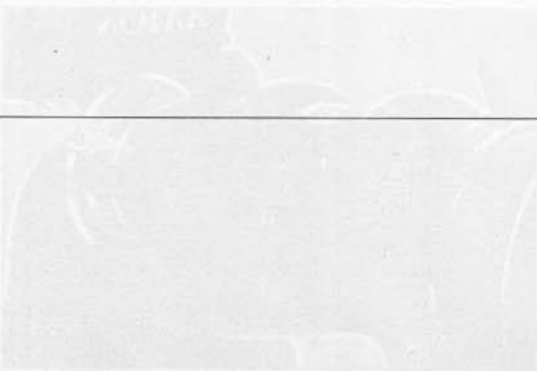

Aaton's flexible lens mounting system allows for the use of a wide variety of 16mm, 35mm and still-photographic lenses.



Flange Focal Distance

Refers to the critical distance from the lens seat to the film plane. The precise FFD of the XTR*plus* is 40mm \pm 6 to $-15\mu\text{m}$ as measured with a depth gauge in the lens port. It is recommended that these tolerances be checked and maintained by a qualified technician. The combination of FFD and back focus distance of a lens directly affects precise focus and overall image sharpness. Make sure these critical measurements are upheld. When using an unfamiliar lens for the first time, check that the eye focus matches the tape-measured focus marks of the lens, and / or shoot a focus test.

1.1 Aaton Lens Port

The Aaton lens port is the standard mounting system for the XTR*plus*. Because the flange focal distance (FFD) of the Aaton lens port is shorter than most professional cameras, the XTR*plus* can accommodate most motion picture and still camera lens mounts. Lenses can be used equipped with an Aaton mount or by adapting another manufacturer's lens mount. Aaton lens adapters are available for Arri standard, Arri bayonet and Eclair CA-1, as well as Nikon and Leica-R photographic mounts.

1.2 Installing the Lens

To install the lens on the camera body, turn the outer locking ring counter-clockwise until it reaches its stop. If the port cap is on, remove it. Align the three protruding flanges on the lens with the three corresponding cutaways in the locking ring and insert the lens into the camera port so that its flanges rest evenly against the lens seat. Tighten the locking ring by turning clockwise until the lens is secured in place and the lock ring is firmly set. Make sure the lock ring is tight enough so that it cannot be inadvertently unlocked.



1.3 ArriPL Lens Port

The *XTRplus* can also be installed with an ArriPL lens port, which is available on option and allows access to all 16 and 35mm ArriPL-mounted motion picture lenses. In order to install the PL port, the Aaton lens seat and locking ring must first be removed. The specific FFD of the *XTRplus* with PL port is 52mm -6 to -15 μ m. Keep in mind that the greater FFD of the PL port forfeits the ability of fitting Aaton, Nikon and Leica-R mounted lenses onto the camera.

Viewing System

2

2.1 Viewfinder Options

The viewfinder is designed to be fully orientable, providing left or right side viewing and an upright image in any position. The viewfinder is equipped with a standard short eyepiece that can be used for handheld and tripod-mounted operation. For more comfortable tripod and studio applications, the standard extension finder can be fitted in place of the short eyepiece. With an Elemak or Mitchell type dolly, or in situations requiring additional reach, the hyperlong finder, which is twice as long as the standard extension finder, can be used.





The Pechan Prism

In order to provide a fully orientable upright image, the Aaton viewfinder incorporates a pechan prism assembly, which is actually comprised of two triangular prisms sandwiched together. On some viewfinders, depending on the construction of this prism, rotation of the eyepiece a full 360° will cause the image in the finder to shift slightly left/right.

After attaching an extension finder, if the image in the finder appears to have shifted slightly, rotate the finder 360° and choose the preferred centered image.

2.2 Attaching the Extension Finder

In order to use an extension finder on the *XTRplus*, the standard eyepiece must first be removed. To remove the eyepiece, locate the eyepiece lock ring, marked **A** in the photo below. Rotate counter-clockwise until the ring reaches its stop and gently pull off the eyepiece. To install the extension finder, locate the protruding guide pin on the seat of the viewfinder and align the pin with the hole in the flange of the finder. Mate the flange to the seat of the viewfinder and tighten the lock ring until it is set firmly in place. During this procedure, you will notice that the extension finder needs to face 180° away from the operator's eye to be installed onto the viewfinder. Because of its optical construction, this is completely normal. After installation, rotate the finder 180° to regular viewing position.

2.3 Viewfinder Tension Adjustments

The large knurled knob at the base of the left/right lateral movement point (**B**) locks the lateral positioning.

The friction adjusting ring, located behind the eyepiece lock ring, can be used to adjust the tension of the eyepiece swivel, depending on the operator's preference and the viewfinder being used. When using the standard eyepiece, tension should be relatively light to allow for movement with a moderate amount of pressure. When using the standard extension finder, tension should be increased to hold the additional weight of this finder in place.

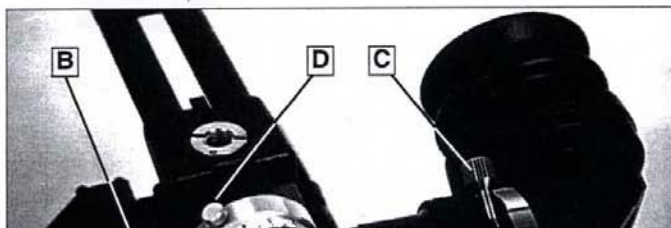

To adjust the tension of the swivel, loosen the steel knurled screw (C) located on the friction adjusting ring. Hold the eyepiece in place, rotate the adjusting ring slightly and retighten the screw; 1/8 of a turn, at first, will have an effect. To increase tension of the eyepiece swivel, rotate the adjusting ring clockwise; to decrease the tension, rotate the adjusting ring counter-clockwise.

2.4 Adjusting the Diopter

Before shooting, the diopter setting of the viewfinder should be adjusted to the operator's eye. To set the diopter, locate the diopter set ring (D) in front of the carrying handle at the top of the viewfinder, and loosen the small knurled knob. Look through the viewfinder, rotate the diopter set ring until the edge of the cross-hair is at its sharpest point and retighten the knob. It is recommended that, for easiest setting, this adjustment be performed with the port cover off and no lens on the camera.

Notice that the diopter set ring is engraved with numbers and dots - use this reference to quickly recall your particular setting when more than one person will be looking through the viewfinder.

The range of the diopter setting is + or - 3. If the range does not reach your particular diopter setting, the viewfinder optics can quickly be adjusted by a qualified technician and the diopter range reset to meet your needs.

If a corrective lens is required, one can be fitted in the recessed area of the eyecup ring of both the standard eyepiece and the extension finder. This area of the eyecup ring can also be used to hold an anti-mist glass.

2.5 The Eyepiece Shutter

In order to avoid unwanted light seepage through the viewfinder, the eyepiece shutter must be closed any time the camera is running film and the operator's eye is away from the viewfinder.

To close the eyepiece shutter on the standard bellows eyepiece, grasp the rubber ring at the base of the eyecup and rotate 1/8 of a turn counterclockwise. On the extension finder and the old style

standard eyepiece, locate the small tab at the base of the rubber eyecup and slide it until the shutter completely covers the eyepiece opening. On the hyperlong finder, rotate the knurled ring closest to the eyecup counter-clockwise to close the shutter.



Checking your Viewing Horizon

There is a simple means of determining whether adjustment of the horizon needs to be made. Mount a zoom lens onto the camera and rest the camera on your shoulder in a standard hand-held position. Look through the viewfinder with your right eye while also keeping your left eye open.

Compose a frame that includes vertical or horizontal lines (a window frame, for example) and adjust the zoom of the lens so that the focal length of the lens generally matches what you see with your left eye.

Ignore the viewing screen markings for the time being and determine whether the rotation of the image you see through the viewfinder matches what you see with your left eye. If it does not, then a fine adjustment may be necessary.

2.6 Adjusting the Viewing Horizon

If the rotation of the image seen through the camera's viewfinder does not exactly match what is seen through the naked eye, there is a fine adjustment that can be made to the image's relative horizon. Locate the small slotted screw located on the underside of the viewfinder just inside the eyepiece lock ring (see photo). Notice that the screw travels in an elongated cutout. Loosen the screw one turn and, while looking through the viewfinder, move the screw within its cutout in order to adjust the horizontal rotation. When the images seen through your left and right eyes coincide, lock the screw.



2.7 Viewing Screen

The unique concave design of the Aaton fiber optic viewing screen gives it its superior sharpness and lucid quality. If your viewing screen possesses a dark blemish or two, don't be alarmed; these spots are actually fractured fibers and are inherent in the manufacturing of fiber screens. Such blemishes, although occasional, are the trade-off for the brilliant screens which result from the use of this technology.

The standard universal screen of the *XTRplus* remains in the camera for both std 16 and Super16 operation and possesses all the markings needed to frame for standard 1.33 aspect, 1.33 TV safe, 1.66 full frame, 1.77 HDTV projection and Super16/1.85. The diagram below illustrates these markings in greater detail.

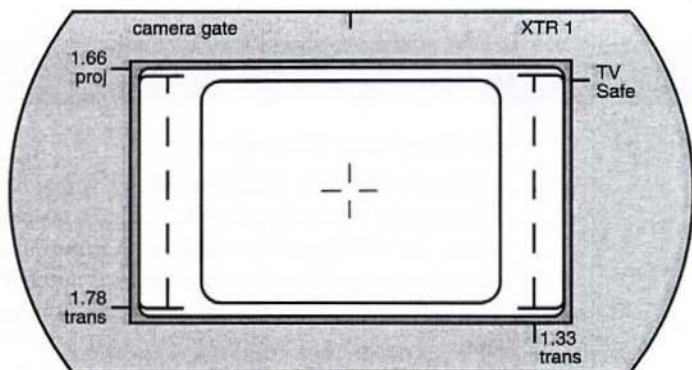

Mirror Shutter

3

The reflex mirror shutter is designed to provide an optical path to the viewfinder while the claw movement advances the film to the next frame. The shutter features a 180° opening necessary for filming under standard 60 Hz HMI lighting at 24 fps without flicker or filming under standard 50 Hz HMI lighting at 25 fps. In order to film at 24 fps under 50 Hz HMI's without flicker, either a 172.8° shutter needs to be used or the HMI lights need to be square wave. While a 172.8° shutter is not available on the *XTRplus* camera, the *XTRprod* model, which features a multi-position 180° , 172.8° , 144° shutter as standard, can be used.

4.1 Co-planar Movement

All Aaton cameras, including the *XTRplus*, incorporate a patented means of advancing the film called a co-planar claw movement. By utilizing this technique, Aaton is able to achieve an ultra-precise pulldown with a minimal number of moving parts. The co-planar concept is the key to the camera's low-noise operation.

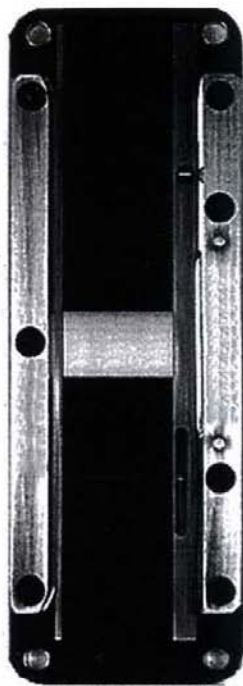

The film gate also features a side pressure bar which is recessed into the claw-side rail at the point of image exposure to assure maximum lateral stability.

This unique, straight forward mechanism design results in horizontal and lateral film registration that is superior to all other 16mm camera movements with an accuracy of 1/2000 of the image dimensions.

4.2 The Hair-Free Gate

In most 16mm camera designs, there is a certain amount of film dust (also referred to as fluff or hair) that is generated as film rolls through the magazine and enters the camera gate. Because the gate and pulldown are the areas where the film must be held most rigidly, these are also the areas where most of the accumulating film dust tends to be deposited. The result could be a visible hair in the picture area and an unuseable shot.

Aaton has taken steps in the design of their magazines and gate assembly to ensure hair and dust-free images. The Aaton magazine features a twistless film path with little sprocket contact, which minimizes the amount of film dust that builds up before entry into the aperture area. Whatever dust does accumulate is filtered through the gate area quickly and efficiently. This is attributed to the design of the gate itself, which features recessed channels on the far edges of the film path and which does not require the use of a polished frame around the aperture opening to keep images in focus.

4.3 Cleaning the Gate

In order to avoid film dust buildup in the recessed channels of the gate, the gate should be inspected during magazine changes and cleaned every three to four mags if the shooting schedule permits. Refer to the **Cleaning** chapter for more detailed information.

*The Aaton Magazine holds 400 ft (122m) of standard 16mm or Super16 film. Shooting at 24 fps, a 400 ft roll will run for 10.5 minutes; shooting 30 fps, the same roll will run for approximately 9 minutes. The coaxial design of the magazine allows for complete self-contained threading, quick mag changes and a minimal amount of loading to be performed in the changing bag. Loading the magazine is a simple operation that, with practice can be performed in a little over a minute. Refer to the **Magazine** chapter of this manual for complete details on loading and caring for magazines.*

5.1 Installing the Magazine

The instant mag design allows for instantaneous switching between mags on the set. To install the magazine on the camera, situate yourself towards the rear motor side of the camera body. If the aperture cover plate is on, remove it. Place your left hand around the front of the camera just underneath the lens area. Grasp the magazine firmly with your right hand below the mid-way point of its rear. While holding the camera body with your left hand, guide the magazine along the base of the camera into the aperture area. Make sure that the top edge of the throat of the magazine is parallel to the carrying handle of the camera as you guide the mag in place. Push firmly and evenly until you feel and hear the magazine snap into place.



5.2 Removing the Magazine

To remove the magazine, situate yourself as before, towards the rear motor side of the camera. Grasp the magazine anywhere which is comfortable at its rear. Place your hand above the motor of the camera and push the mag release lever towards the front of the camera with your thumb. Pull the magazine straight off the camera with your right hand.

XTRplus body requires only 12 volts for all aspects of operation. One standard Aaton on-board (12V 1.8 ah rechargeable nicad) will power the camera, CCD and any accessories which are connected to the body's accessory inputs (such as zoom controls, speed controls etc.) through a standard 4 pin XLR connector. One 1.8 ah on-board battery will run 9-11 magazines on the XTRplus, without CCD and accessories. With accessories in use, this number will decrease.

6.1 Installing the Battery on the Camera

The on-board battery fits below the CCD control unit on the battery side of the camera body. In order to install, loosen the black knurled screw approximately four or five turns. Push the battery evenly onto the XLR4 connection on the body. When snug, tighten the knurled screw onto the battery tab to hold it in place.

When running AatonCode, get into the practice of having a fresh battery on hand before removing the one from the camera. Even a low battery that no longer runs the body (below 10V) will have enough voltage to keep accurate time counting.

Thanks to a super capacitor built into the camera base, you will have a full minute to change the battery before time is lost. After replacing the battery, confirm that time is still counting by looking for the yellow blinking diode to the right of the motor or checking the Control Panel.

6.2 Battery Charging

The Aaton on-board can be recharged with an appropriate 12V nicad battery charger.

For the best results, use a microprocessor-controlled charger or a standard trickle charger with a charging output of at least 200ma, both of which prevent the overheating and mistreatment of your nicad cells. Always follow the specific guidelines of the charger manufacturer.

Beware of older, timed chargers manufactured when 1.2 and 1.4-ah batteries were the norm; these chargers were most likely rated for the lower amperage batteries of that time and will consistently undercharge the higher rated nicad cells of today.

6.3 Other Power Options

Since the *XTRplus* power input is a standard 4pin XLR type, a great variety of 12-14 volt sources can be used to power the camera. This includes AC power supplies, battery blocks, lithium cells and car batteries.



Nicad Battery Tips

Follow a few simple rules to insure the long life of your nicad cells:

- Allow batteries to run through their normal cycle of charging and use. Avoid topping off partially full batteries. Once every few months, discharge cells to 8-10V using a standard discharger to minimize their memory.
- Do not rapid-charge your cells more than necessary, as the added heat will eventually shorten their life span. Instead, recharge batteries at a normal charging rate when your schedule allows.
- If your batteries will not be used for long periods of time, always store them in a cool, dry environment fully charged.

Get into the habit of carrying a standard XLR4 powercable in your package in case an alternative power source is needed.

Regarding AC power supplies, it is recommended that the unit you use be at least 4 amps and 25 watts. Before connecting any non-standard source, always make sure that the pin configuration of the unit is correct. See the **Technical Specifications** chapter of this manual for details for proper wiring.

The tri-phase salarium motor design of the XTRplus provides low power consumption and improved stability at high speeds. The body is capable of speeds between 3 and 75 fps with a standard 12V battery.

7.1 Camera Speeds

The XTRplus provides dial-in crystal speeds of 6, 12, 20, 24, 25, 29.97, 30, 48, 50, 60, 75. With the use of an external speed control, any speed between 3 and 75 in .001 frame increments can be achieved.

The speed dial is located at the rear of the camera base towards the battery side. As a precaution, if the speed is adjusted while the camera is running, the change will not take place until the next camera start.

7.2 Using an External Speed Control

When using an external speed control, the camera's speed dial must be set to **ext**. If a speed control is connected and the speed dial is not set to **ext**, the camera will run at the speed indicated on the dial.

Keep in mind that, with certain manufacturer's speed controls, it may be possible to run the camera at speeds higher than the 75 fps factory limitation. Overcranking in such a way, however,

will increase mechanism wear, increase noise and compromise image registration. Aaton urges to avoid such usage at all cost and will not be responsible for the resulting damage that may occur. This top speed cap of 75 fps has been designated by Aaton because it is the level at which the camera can run safely without any adverse effect on its mechanics.

7.3 Electronic Inching

The inching function of the motor is accomplished electronically and can be accessed in a number of ways.

From the Body

The large run/test switch on the motor side of the body, not only runs the camera, but provides half frame inching for gate inspection, lightmeter functions and loop situating when installing a fresh mag.

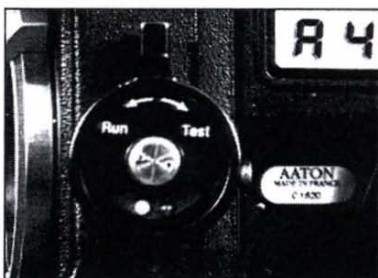

From the Handgrip

The wooden handgrip switch, by way of the Lemo2 connector, provides camera run and full frame inching for single frame operation and loop situating.

From a Remote Cable

The Lemo2 connector, as well as the Lemo6 and Amph9 accessory connectors, provide the capability of using a remote on/off with either a half-frame or full-frame inching function.

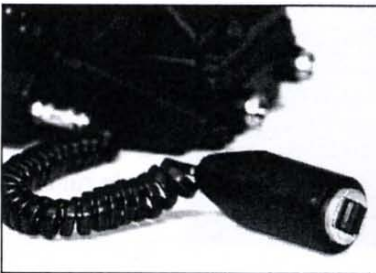

7.4 Single Frame Operation

With the use of the electronic inching switch via the wooden handgrip or a remote cable, the *XTRplus* can be used as a simple intervalometer for single frame operation. Each frame is 1/4 sec exposure.

ASA Setting

8

When using the internal lightmeter and/or AatonCode in the *XTRplus*, the ASA knob must be set to the exposure index of the film stock being used. The ASA knob provides selections between 64 and 800 ASA.

With regards to the lightmeter, the setting on the ASA knob dictates to the camera what the exposure should be for a particular film stock. For AatonCode, proper ASA selection will insure that the timecode matrix recorded on the edge of the film in the gate will be exposed at an appropriate and useable level.

If the ASA knob is moved while the camera is running, the adjustment will take place until the next camera start.

If the internal lightmeter is not being used and there is no timecode running in the camera, the ASA knob setting will have no effect.



Force Processing and the AatonCode matrix

Regardless of the situation, always set the ASA knob to the actual exposure index of the film. If you know beforehand that your footage will be pushed or pulled, don't worry about compensating for the sake of the precise exposure of your timecode matrix. The matrix is resistant enough to handle exposure variances of one and a half stops or more in either direction.

Lightmeter

9

The XTRplus is equipped with an internal lightmeter that is designed to read the quantity of light reflected off the film itself. For added accuracy, the meter measures the light by means of two photocells. The metering system automatically compensates for filters and changes in camera speed.

9.1 Display



Diagram A, above, with the center diode unlit, indicates proper exposure.

Diagram B, below, illustrates one stop underexposed;

Diagram C illustrates one stop overexposed.



Through the viewfinder, the lightmeter display is positioned directly above the viewing screen across the top of the frame. A single darkened diode moves across an array of 13 yellow and green diodes, indicating proper exposure. (see diagram) Each diode represents one third of a stop, while normal exposure darkens the center green diode. Underexposure of -2 stops or more darkens the green diode on the left end of the row; overexposure of +2 stops or more darkens the green diode on the furthest right of the display.

To the immediate left of the display is the Red Diode Indicator, which has the same functions as the Red Diodes on the left and right sides of the body. See section 12, **LED Indicators** for further details.

9.2 Operation

Because the lightmeter takes its measurement as a reflection off the film, you must have film in the gate for the camera to provide an accurate reading.

To use the lightmeter, follow these simple guidelines: Set the ASA knob to the exposure index of the film stock being used. Set the camera to run or test position and adjust the lens iris until the center green diode is darkened; this will be your proper metered exposure.

Remember, the lightmeter is giving you an average reading of the entire frame. You may choose to vary the suggested exposure according to subject conditions.

9.3 Using the Lightmeter without Running Film.

It is also possible to use the lightmeter without actually running the camera. Set the ASA knob to the exposure index of the film being used. Set the camera to test position using the on/off switch on the body or the handgrip. If the handgrip is used, the momentary switch must be held in the test position. The mirror shutter will rotate 180 allowing light from the lens to reach the film and a reading to be taken by the meter. Adjust the lens iris until the center green diode is darkened, indicating proper exposure.

9.4 Testing and Adjusting the Meter

If you are operating the lightmeter for test purposes, don't forget to have film in the gate before taking a reading.

The following is the procedure for checking and adjusting the sensitivity reading of the lightmeter:

- 1 - Evenly light a standard 18% grey card.
- 2 - With a loaded magazine and lens on the camera, frame the chart so that it completely fills the Super16 frame.
- 3 - With a properly calibrated handheld lightmeter, take a reading of the grey surface and set the T stop of the lens accordingly.
- 4 - Switch the camera to run or test position and check the position of the darkened diode. If the center green diode is darkened, the camera's lightmeter is set correctly. If the darkened diode is to the left or right, it is possible to adjust its reading.
- 5 - To access the lightmeter potentiometer, remove the complete viewfinder by means of the four screws which mount it to the front housing. Locate the hole between the two viewfinder screwholes on the top motor side of the front housing. The white potentiometer will be visible within this hole.
- 6 - With a small screwdriver, adjust the potentiometer slightly; 1/8 of a turn will have an effect. Rotating clockwise will correct an overexposure and move the darkened diode to the left; rotating counterclockwise will correct an underexposure.
- 7 - In order to check your adjustment, replace the viewfinder, tighten the four screws and repeat the procedure from step 4. When the reading through the camera matches your handheld meter, the adjustment is complete.



Adjustment Tips

While adjusting the sensitivity of the lightmeter, you may wish to use your direct view of the display through the body's top cavity for reference. If so, there are a few points to remember:

- Because the image is inverted without the viewfinder in place, your adjustments will move in the opposite direction than seen through the finder.
- Since the cavity is open, light will enter through this opening, making any reading inaccurate by 1/3 to 2/3 of a stop. Therefore, only use the direct view of the display to reference the number of diodes adjusted. Always check your final adjustment with the viewfinder in place.

9.5 Turning the Lightmeter Off

If the lightmeter is not being used, it may be turned off. The on/off toggle switch is located on the operators side to the left of the motor. Keep in mind, the red diode indicator and end-of-film warnings will function whether the display is on or off.

As a standard feature, the *XTRplus* is equipped with the capability of recording AatonCode in-camera time. Timecode information is exposed onto the film by means of seven micro-diodes, which are relayed, by means of fiber optics, into the gate above the claw to the right of the aperture opening. These micro-diodes flash rapidly to form the code as the film rolls through the gate between exposures.

Because the Aaton timecode system is completely self-contained in the camera body, any XTR-compatible magazine (DX style) can be used on cameras recording AatonCode.



Furthermore, the size or position of the film loop does not, in any way, affect the accuracy of the recorded timecode.

AatonCode is initialized in the camera, in ASCII or SMPTE form, through the Lemo5 connector located to the left of the motor on the motor side of the body. For the most straightforward and reliable communication, OriginCplus, Aaton's master-clock, comparator, and SMPTE generator device, should be used.

For more elaborate information regarding the uses and functioning of AatonCode, OriginCplus and other related devices, refer to the **AatonCode** chapter of this handbook.

*The following operator controlled parameters can be monitored by the LCD display of the XTRplus. For more concise information, see the table in the **System Features and Controls** chapter of this manual.*

11.1 AatonCode

If AatonCode has been initialized in the camera, the display will indicate the running timecode any time the on/off switch is in the **off** position. The XTRplus will alternately display hours/minutes, then minutes/counting seconds.

11.2 ASA Setting

With the magazine **off** the camera, switch the camera on/off switch to **test** position. The display will show the ISO setting of the ASA knob.

11.3 Battery Voltage

With the magazine **on or off** the camera, press button 3; the display will read and indicate the voltage of the attached battery. Notice that, if the camera is running and button 3 is pressed, the display will indicate the voltage under load.



Indicating 29.97 fps on the LCD Display

If the dial speed is set to 29.97 fps, the display will indicate 30.0 because its reading has been rounded off to the nearest 0.1 of a frame. Likewise, when using an external speed control capable of .001 accuracy, the display will indicate the speed to the closest 0.1 of a frame.

11.4 Camera Speed

With the camera **running**, press button **2** for a reading of the camera's frames per second rate. Note that the display is not merely indicating the speed setting on the FPS dial, but rather the actual running speed of the camera to the nearest tenth of a frame.

11.5 Footage Remaining

The display will show the mag ID (A, B, C) and the memorized footage remaining any time the camera is **running** with a magazine **on**. For more information regarding Mag ID, refer to section 4 of the chapter entitled **The Magazine**.

With a fully loaded magazine on board, simultaneously press buttons **1 & 3** to reset the display to count down a **full 400 ft** load. If a short end is being used, press 1 & 3 to reset to 400 ft, then press **1 & 2** to adjust the displayed footage to the approximate **short end** load.

Note that the camera does not take a physical reading of the film roll to determine the footage reading on its display; it is only a counter and it must be set by the user. There is, however, a mechanical footage counter on the magazine that automatically measures the size of the camera roll; use the magazine footage counter to determine the correct short end length to input on the LCD display.

11.6 Feet or Meters

With the magazine **on** the camera, simultaneously press **all three** buttons to switch the footage counter between meters and feet.

11.7 Software Version

With the camera on-off switch in the **test** position, press button **2**; the display will show the software version of the lightmeter eeprom, which also controls all display functions.

The XTRplus utilizes LED indicators in three locations to convey information: in the viewfinder and on both left and right outside of the camera body.

12.1 Camera Test Indicator

A **blinking red** diode (long on, short off) is activated in all three locations when the camera is in test position. On the outside of the body, this will be accompanied by a **solid yellow** diode.

12.2 Camera Run Indicator

A **solid yellow** diode on the sides of the camera, with the absence of a red diode indicates that the camera is running and receiving an acceptable voltage (10-14V).

12.3 Low Battery Indicator

If the yellow diode is accompanied by an evenly **flashing red** diode (same duration on and off), this indicates that the camera is receiving a voltage of 10V or below and that sync will soon be lost (within 5 minutes of camera run time) The flashing red diode alone will also be activated in the viewfinder.

When the input voltage reaches a level too low to run the camera at crystal speed, the body will automatically shut off.

12.4 End-of Film Warning Sequence

The lightmeter display features pre-end-of-film and end-of-film warnings for the operator.

Under normal operation, the lightmeter display will flash once for every foot or meter that is counted down. When the footage counter on the LCD display counts down to **10 feet remaining**, the display will flash more rapidly, at a frequency of about **2-3 times per second**. Keep in mind, the pre-end-of-film warning will only operate if the lightmeter display is turned on.

When the counter reaches **zero**, the left and right sides of the display will **alternately flash**, indicating the end of a roll. The end-of-film warning will function whether the lightmeter display is on or off.



Insuring an Accurate End-of-Film Warning

The lightmeter display uses the countdown of the LCD display's remaining footage to activate the pre-end-of-film and end-of-film warnings. For these warnings to be accurate and useful, it is essential that the digital footage counter be properly set when a full roll, as well as a short end, is loaded.

The XTRplus uses six main connectors for power and accessory input. Following is a detailed list of the location and main functions of each.

13.1 XLR4 - Power In

The XLR4 connector, located on the bottom of the PBX panel, is the **main power** input. It is designed to accept a standard on-board battery or an XLR4 powercable to another power source such as a battery belt, block or AC power supply.

13.2 Amph9 - Accessory Input

The Amph9 connector, located at the top of the PBX panel, is one of two main accessory connections on the XTRplus and provides +/-, Hz, and camera **on/off**. It is designed to accept a crystal speed control as its main input but will power any accessory (such as power zoom) and provide remote on/off control as well.

In the instances where the video assist VR42 or VR46 is used, the CCD control unit is plugged directly into Amph9 and a duplicate Amph9 connector is provided on the side of the control unit near the CCD on/off switch.

13.3 Lemo14 - CCD Assist

The Lemo14 connector, located directly underneath the Amph9 connector on the PBX panel, mates the CCD head assembly to the CCD control unit. When the CCD control unit is fastened to the body, it connects to the Lemo14 and the Amph9 (described above).

Keep in mind that this connector can only be used for CCD assist; if the CCD head is not installed in a particular XTRplus body, the Lemo14 will not be present and a black plug or blank plate will seal the connector port.

13.4 Lemo6 - Accessory Input

The Lemo6 connector, located on the battery side at the rear of the base, is the second of two main accessory connections on the

XTRplus and provides +/-, and camera **on/off**. It is designed to accept a power zoom as its main input but will accept any accessory which does not require a sync signal, and provide remote on/off control as well.

13.5 Lemo2 - On/Off Input

The Lemo2 connector, located on the battery side at the front of the base, provides camera **on/off** and is primarily used to carry handgrip on/off functions to the camera body. The Lemo2 can also be used for remote on/off control.

13.6 Lemo5 - Timecode Input

The Lemo5 connector, located on the motor side to the lower left of the motor, is the timecode interface. It is used when recording AatonCode and provides **timecode** communication in both **ASCII** (in/out) and **SMPTE** (in).

The Aaton VR42 black & white and VR46 color CCD taps are designed to add video assist capability to the XTRplus without compromising the body's size, flexibility and ease-of-use. Because the CCD head is incorporated into the XTRplus camera body, there are no centering or focus adjustments necessary (unless, of course, when converting the body between 16 and Super16 formats). The control units for all Aaton CCD assists attach quickly to the camera's PBX housing and can be used with an on-board battery.

14.1 Installing the Control Units

The VR42 and VR46 control units can be easily attached onto the XTRplus in a few seconds without the need for adjustment.

Remove the two allen screws located on the PBX immediately below the Lemo14 connector. Mate the amph9 and Lemo14 connectors of the control unit to those connectors on the body and plug in the unit.

Replace the two allen screws to fasten the control unit; a third screw of the same size should be screwed into the upper right side of the unit from the opposite direction.

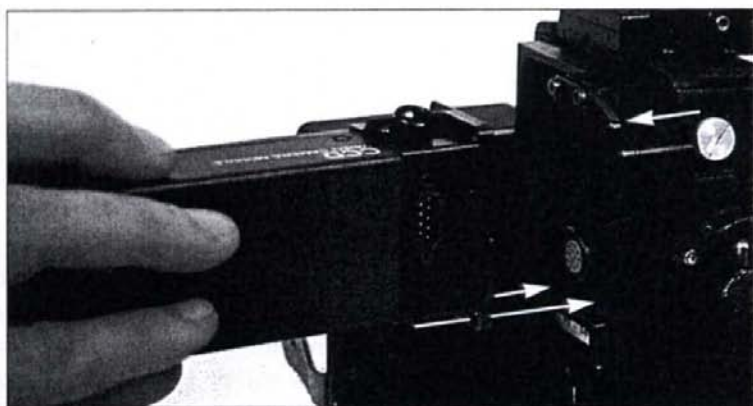

The control unit can remain permanently attached to the XTR*plus* without adding discernable bulk or weight. Simply keep the unit turned off and the beamsplitter retracted (see below) when video assist is not needed.

14.2 The Internal Beamsplitter

The Aaton CCD assist system employs an internal, user-retractable beamsplitter that reroutes a portion of the viewfinder's light path to the CCD target while the video assist is in use. In situations which do not require the CCD assist, the beamsplitter is designed to be retracted to allow 100% of the viewfinder's light to reach the eyepiece.

From body # 1928 and on, the beamsplitter delivered as standard from the factory has a 75/25 reflection ratio. This means that 25% of the light from the viewfinder is sent to the CCD target when the beamsplitter is in place. This 75/25 ratio is ideal for use with Aaton's VR42 black and white CCD. Although not visible from the outside of the body, the 75/25 beamsplitter is identified by its blue anodized holder.

Also available is a 50/50 beamsplitter, which sends a greater percentage of light to the CCD target. This beamsplitter is recommended for use with the VR46 color CCD and is distinguished by its black holder.

14.3 Positioning the Beamsplitter

The beamsplitter adjustment screw is located underneath a small, capped port on the battery side of the camera. To access the beamsplitter, unscrew and remove this silver cap. A 1.3mm allen head adjustment screw will be visible through the opening. With an allen wrench, gently rotate the adjustment screw approximately 30 turns in the desired direction to position or retract the beamsplitter.



After 30 or so turns, the adjusting screw will reach its stop and resistance will be felt. At this point, stop and rotate the adjusting screw one turn in the opposite direction to complete the adjustment. By backing the beamsplitter off its stop, fine centering of the CCD target is maintained and the beamsplitter itself is less susceptible to residual shocks caused by a drop or sudden jolt.

Positioning the Beamsplitter for video use - the adjusting screw should be rotated **counter-clockwise** to move the glass in place.

Retracting the Beamsplitter for non-video use - the adjusting screw should be rotated **clockwise** to move the glass out of viewing area.

14.4 The Beamsplitter Axis Adjustment

The beamsplitter axis adjustment is used to recenter the CCD assist image when switching between 16 and Super16 formats. If the CCD image on your monitor appears off to one side, the angle of the beamsplitter must be adjusted.

The beamsplitter axis adjustment is located to the above/right of the aperture and consists of an allen screw within a slot. A red dot to the upper left of the slot indicates the position of the screw for Super16.

Loosen the allen screw one turn; while looking at the monitor move the screw within the slot in the appropriate direction until the image of the screen is centered. Afterwards, if the image is not sharp, follow the directions under 14.7 **Installing the CCD Head** to adjust focus.

14.5 The Manual Iris

The VR42 and VR46 CCD assists feature an automatic gain. In certain situations, however, further light control may be desired (such as high contrast or strong back-light circumstances). In these instances, it is recommended to employ the manual iris feature of the *XTRplus*, which is located on the CCD head cover on the battery side of the camera.

Under normal operation, this mechanical iris should be wide open; check that the iris indicator on the CCD cover is pointing to the large circle, indicating an open iris. The VR42 utilizes a black lever as an iris indicator; the VR46 incorporates a silver dial with a black dot. When further light control is necessary, look at a video monitor and move the iris indicator towards the small circle to the desired degree.

14.6 Battery Life with CCD Assist

The VR42 assist draws 180-200ma when powered. This translates into approximately 8 to 9 hours of operation (without the *XTRplus* running) from one 12V 1.8 ah on-board battery.

Although battery life will vary greatly depending on the amount of film run and the number of accessories powered from one



No Image? Check the Beamsplitter First.

A battery is connected, the CCDs power is on, the lens cap is off, but still no image on the video assist monitor...? Before doing anything drastic, double check that the beamsplitter is in place. It is the one simple step which is most often overlooked.

power source, you could estimate that one 12V on-board could run 4-5 magazines and the VR42 for 4-5 hours. In order to conserve battery life, get into the habit of shutting off the assist when not in use.

The VR46, on the other hand, because of its color, frame-store and timecode capabilities, draws 730-750ma, which translates into approximately 2 to 2.5 hours of operation from one 12V 1.8ah on-board battery. For this reason, it is recommended to use a battery block or AC power supply when using the VR46 for long periods of time.

14.7 Installing the CCD Heads

Under normal circumstances, if you own a VR42 or VR46 CCD assist, you will not need to deal with the removal and/or installation of the CCD head. The head and its accompanying relay lens are designed to remain within the camera body whether the assist is being used or not.

In some instances, however, such as the renting or sharing of a unit among a few cameras, it would be necessary to remove and install this head.

The installation and removal of the VR46 color head assembly is somewhat involved and considered a shop operation. It is recommended that this procedure be performed by a qualified technician. The VR42, however, is much more straightforward; the following is the procedure for its installation.

1 - Unscrew the four allen screws as indicated in the diagram on page 41 and remove the PBX cover plate and rubber gasket. On the cover plate, you'll notice a plastic plug which is press-fit into the cover plate. Remove this plug by pushing it to the inside of the plate. If it is very tight, use a pencil eraser to do the job.

2 - Remove the four screws which hold the CCD cover onto the battery side of the camera and carefully remove the CCD cover. If you do not own a VR42, you may have a flat plate in place of the CCD cover.

3 - Check that the exposed lens of the CCD head assembly is free of dust particles. If necessary, clean this surface with lens

fluid applied with a foam or cotton Q-tip. In order to install the head assembly into the side cavity, first feed the Lemo14 connector into the PBX so that it faces towards the rear of the camera, then install the head assembly into the tubular holder until the steel collar is stopped by the tube.

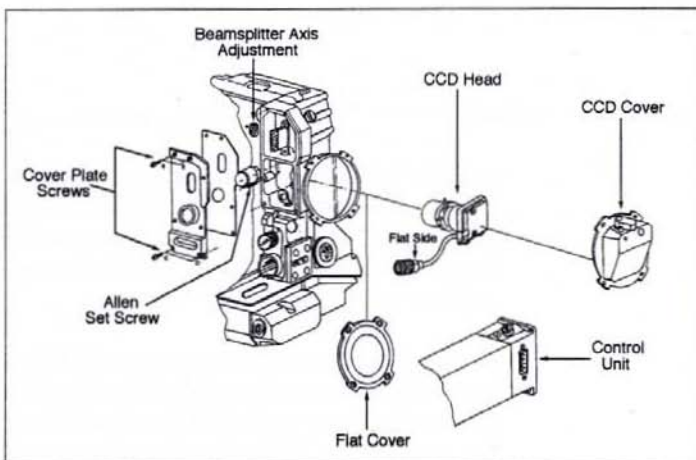

4 - While holding the head assembly in place, locate the allen set screw located within the left side of the PBX (see diagram) and tighten moderately until the head assembly is secure. To avoid any damage to the relay lens housing, do not overtighten this screw.

5 - Position the Lemo14 in its cutout within the PBX and hold in place. Make sure that the flat index towards the rear of the connector faces up and mates with the flat in the cutout. Do not confuse this flat with the two flats on the threaded portion of the Lemo.

6 - Replace the rubber gasket and the PBX cover plate via the four allen screws. Double-check that the Lemo14 sits flush against the lip of the circular opening in the cover plate.

7 - Plug the control unit into the PBX and fasten it to the body with three allen screws. Connect a BNC cable to a monitor and power the XTRplus. Turn on the toggle switch of the CCD assist; the yellow diode should light. You should also see an image of the viewing screen on the monitor. If this is not the



WARNING

When installing the CCD head, make sure that the Lemo14 connector is properly installed with the flat side up. Only attach the control unit if the PBX cover plate is reinstalled and the Lemo14 is in place, flush to the cover plate. Improper orientation of this connector can cause major electronic damage if connected to the control unit and powered.

case, the beamsplitter may be retracted. Remove the beamsplitter access cap on the battery side of the camera and position the beamsplitter by rotating the adjustment screw approximately 30 turns counter-clockwise until it reaches its stop. Back off the stop one turn clockwise.

8 - Locate two allen head screws on the CCD head (A) identified by a red dot. Loosen the screws 1/2 a turn. While looking at the monitor, gently move the CCD head until the viewing screen image is in focus. Notice that this adjustment also affects image rotation. When sharp and even focus is achieved and the image is square to the monitor, tighten the two screws.

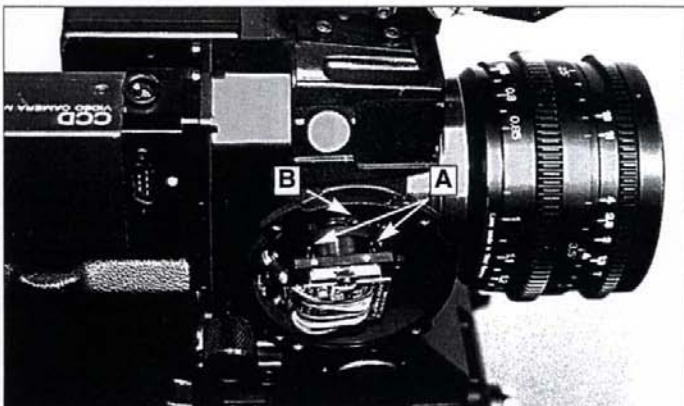

9 - If the CCD image is centered in the monitor, your adjustment is complete. However, if the image is off to one side, the beamsplitter axis adjustment needs to be reset. Follow the directions under **14.4 The Beamsplitter Axis Adjustment** to recenter the image. Afterwards, loosen the two screws on the CCD head and refocus the optics.

10 - Locate the iris rod on the CCD head (B) and move it by hand to an upright position. Replace the CCD cover on the body; take care to locate the iris control fork and position it around the iris lever. Tighten the four screws to secure the cover in place. Operate the manual iris lever and check that the CCD iris itself is functioning by looking at the monitor. If the brightness of the image does not change, the iris rod may not be engaged in the control fork. If this is the case, remove the CCD cover and repeat the procedure.

Correcting a Dark or Grainy CCD Image

If your CCD image appears darker or grainier than expected, it may be that the travel range of the iris lever is such that it does not open the manual iris completely. If the unit is set properly, the iris lever and fork, when moved right, should be able to move the internal iris rod to the left until it rests against the left wall of the cutout. If this is not the case, the relay lens, which houses the iris, must be rotated clockwise in relation to the CCD head.

To do this, first remove the control unit and PBX cover plate. Next, loosen the allen screw described in step 4, rotate the entire CCD head and relay assembly slightly clockwise and resecure. Follow steps 5 through 10 to readjust the focus and rotation of the image.



The Magazine

...the first time ...

...the first time ...

...the first time ...



...the first time ...

...the first time ...

The Aaton DX Magazine incorporates many features which add to the camera system's ease-of-use, efficiency and reliability. The magazine's coaxial design allows for separate feed and take-up chambers, which ensures that the bulk of the loading process is performed in daylight.

The DX Magazine is driven magnetically from an intermediate drive connected to the camera motor; a magnetic wheel on the inner side of the camera body couples with a similar wheel on the throat of the magazine to transport the film. This magnetic drive system decreases noise and power consumption, and prevents mechanical stress during mis-loads.

The magazine handles up to 400 ft (122m) loads of double or single perforated 16mm film stock. 400 feet of film is approximately 10.5 running minutes at 24 fps.

2.1 DX Magazines

Since the introduction of the XTR in 1984, only DX magazines have been manufactured by Aaton, all of which can be used on today's XTR*plus* (approximate ser #3500 and above). The DX code distinguishes this magazine from earlier designs. **D** refers to its emulsion-out Super16-safe coaxial roller (further explained below). **X** refers to its magnetic drive system.

2.2 Super16 Safe

All DX magazines are designed to safely transport either standard or Super16 stock. Capped rollers keep the running film from riding up and prevent any contact within the picture area. The mag's large coaxial roller, which transports the film from the feed into the take-up chamber, handles the film on its less-sensitive base side and facilitates a long and twistless film path. (Severe twisting of the more sensitive high speed stocks, as is the case with the LTR and some other manufacturers' magazines, has been known to cause grain fracturing and a resulting abnormal exposure of the film in that area.)

The DX magazine features two pressure plates which are located at the front of the nose of the magazine. When the loaded magazine is attached to the camera, these pressure plates provide the precise stabilization of the film during exposure and transport.

3.1 The Picture Plate

The upper four-stripped pressure plate, called the picture plate, is positioned at the camera's aperture opening and is designed to hold the film steady at the point of exposure. Proper setting and functioning of the picture plate assures the precise focus of each image.

3.2 The Claw Plate

The lower plate, called the claw plate, is positioned at the pulldown claw and functions to stabilize the film as the claw engages the film perf between exposures. Proper tension and functioning of the claw plate contribute to reliable transport and quiet operation.

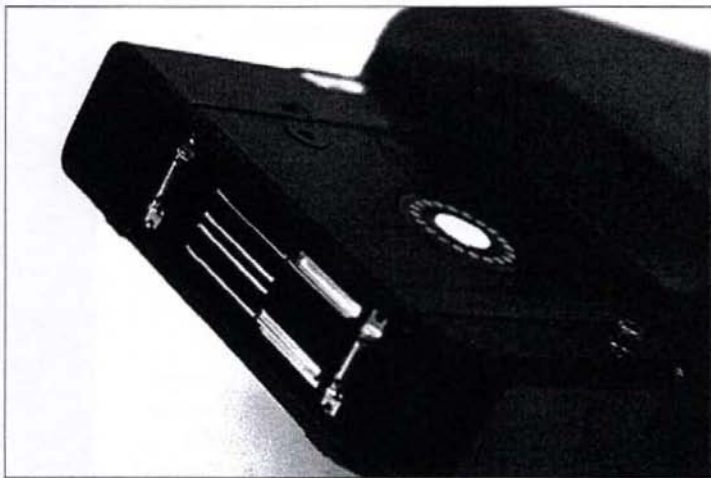

The straightforward design of the DX magazine allows for quick, easy loading and an absolute minimum amount of threading in the dark. The film does not need to be cut in preparation for loading.

5.1 Feed Side - In the Changing Bag

- Place the film can and the magazine, feed side up, in the changing bag and zip closed.

- Disable the mechanical footage counter, located on the feed door, by rotating counter clockwise until it locks in its recessed position.

- Unfasten the feed door lock by turning downward and open the feed door.

- Remove the film from its can and bag.

- On the feed core holder, squeeze the core lock mechanism on either side with thumb and forefinger to release core lock.

- Place the film on the feed spindle with its wind clockwise and press the center of the core lock to lock the core in place.

- Thread 4" of film around the outside of the lower guide roller and through large coaxial roller emulsion out. Make sure that the length of film feeds completely through to the take-up side.

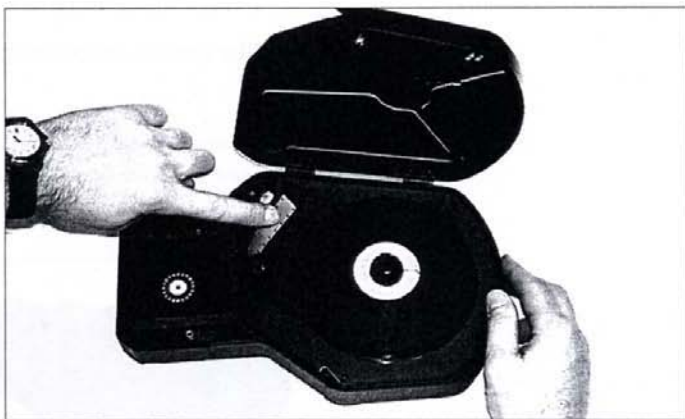

Care for your Changing Bag

A clean and light-tight changing bag is the only thing separating your precious footage from a veritable washout. Before using your changing bag each day, turn it inside out and shake it clean of dirt and debris. It is also a good practice to periodically inspect its edges for holes and tears. Hold it up to a strong light to check for any pin hole leaks.

- Close and lock the feed door and engage the footage counter by rotating clockwise.

- Remove the magazine from the changing bag.

5.2 Take-up Side - In Daylight

- Unfasten the take-up door lock by rotating downward and open the door.

- Release the doors of the upper and lower pinch rollers by pressing the white buttons and gently pulling open.

- Pull the length of film from the slot of the coaxial roller and pass below the first idler roller. Bypass the upper sprocket for the time being and push the film directly through the upper channel slot to the outside of the nose. Pull through about one foot in length.

- Reintroduce the film into the lower slot, back into the magazine.

- Place a plastic core onto the take-up spindle, check that the core is seated properly, and press the center of the core lock to lock the core in place.

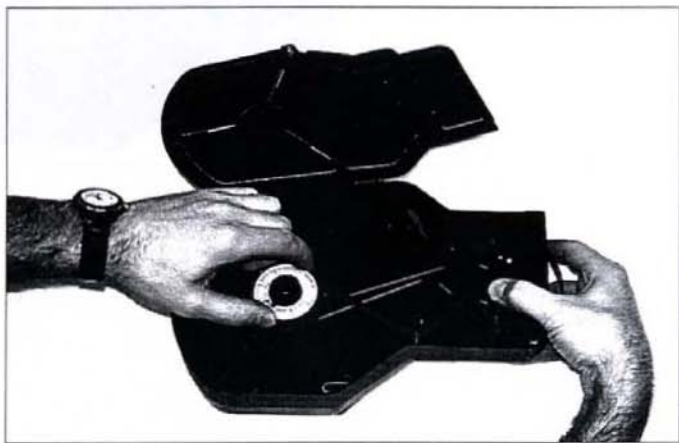



The Two-Finger Rule

When loading the take-up side of the magazine, the loop size can quickly be measured by inserting two fingers within the loop perpendicular to the mag's pressure plates. At first, determine proper loop size by pulling the looped film away from the mag, counting and adjusting for



15 to 16 visible perforations for a length 14 to 15 frames long. Then, insert two fingers and check how the spacing relates to the proper

loop length. Of course, each person's finger-measured equivalent will be slightly different, but for most people, a tight two-finger length is approximately a 14 frame loop, a loose two fingers is about 15 frames. After you become familiar loading the mag, you should be able to use the two-finger method to save time setting your loop.

- Bypass the lower sprocket for now and pass the film underneath the lower roller. Fit the film end into the plastic take-up core and wind on a few turns counter-clockwise and emulsion in.

- Thread the film around the lower sprocket, making sure the film's perforations engage the sprocket teeth. Close the lower pinch roller until it locks firmly in position and a noticeable click is heard.

- Hold the lower sprocket with your right thumb and rotate the take-up core counter-clockwise to remove any slack.

- Thread the film around the upper sprocket and adjust the loop until its taut length is 14 to 15 frames long outside of the nose. When the proper length is achieved, close the upper pinch roller until it locks firmly in position.

- Remove any slack, then close and lock the take-up door.

5.3 Installing the Loaded Magazine

Before installing the magazine, make sure the film loop is centered; pull out the length of film loop, center its length top and bottom, and push back against the mag's pressure plates.

To install the magazine on the camera, situate yourself towards the rear motor side of the camera body. Place your left hand around the front of the camera just underneath the lens area. Grasp the magazine firmly with your right hand below the midway point of its rear. While holding the camera body with your left hand, guide the magazine along the base of the camera into the aperture area. Make sure that the top edge of the throat of the magazine is parallel to the carrying handle of the camera as you guide the mag in place. Push firmly and evenly until you feel and hear the magazine snap into place.

To engage the film, turn the camera to test position and off again until a noticeable click is heard.

5.4 Removing the Magazine

To remove the magazine, situate yourself as before, towards the rear motor side of the camera. Grasp the magazine anywhere which is comfortable at its rear. Place your hand above the motor of the camera and push the mag release lever towards the front of the body with your thumb. Pull the magazine straight off the camera with your right hand.

IV

The Aaton System

about input model 1 1
... ..
... ..
... ..
... ..
... ..

... ..
... ..
... ..
... ..
... ..



... ..
... ..
... ..
... ..
... ..

The XTRplus is designed to be easily converted between the following three accessory configurations:

1.1 15mm Front Rods

The most versatile and popular configuration for accessorizing the XTRplus camera, the universal 15mm screw-in front rod system can instantly accept Aaton, Arri, Chrosziel, Petroff and other manufacturers' mattebox and follow focus systems. Utilizing the front rod system allows for quick conversion from tripod to shoulder operating modes without the need for reconfiguration.

Aaton manufactures 50mm and 100mm length rods that screw directly into the front housing of XTRplus underneath the lens port.

The 15mm front rod system is recommended when standard size lenses and accessories are to be used or when quick conversion between tripod and handheld modes is necessary.



1.2 Sliding Bridgeplate

The XTRplus can also accept standard 15 and 19mm sliding bridgeplates for building the camera system for high-end studio work. The bridgeplate configuration can accept Aaton, Arri,

Chrosziel and other manufacturers' mattebox, follow focus and support equipment that is designed for bridgeplate use.

Standard bridgeplates from Aaton, Arri and other manufacturers can be attached to the *XTRplus* by means of the 3/8-16 tripod receptacle on the underside of the camera.

The sliding bridgeplate system is recommended when large 35mm lenses and accessories are to be used, when using a geared head or when the highest possible production value is necessary.

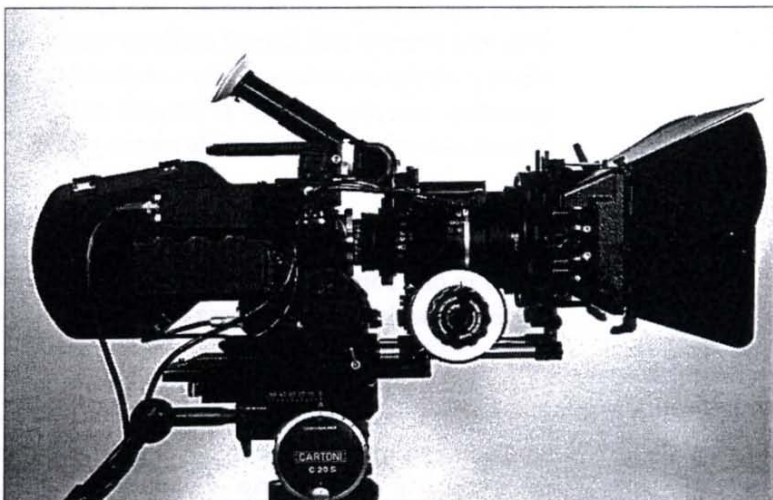

1.3 Lateral Bracket System

Another option for studio work is Aaton's lateral bracket system. The *XTRplus* can accept Aaton, Panavision and Chrosziel mattebox, follow focus and support equipment that is designed for the lateral system.

Aaton's lateral bracketry can be attached to the *XTRplus* by means of four allen head screws located on the PBX on the battery side of the camera.

The lateral bracket system is recommended when large 35mm lenses and accessories are to be used, when using a geared head or when the highest possible production value is necessary.

The XTRplus body includes a wooden handgrip, short 15mm rods, rod coupler and Lemo2 cable as standard. The handgrip, which is designed to be used for comfortable hand held operation, can also be used to provide on/off control on the battery side of the camera while on the tripod.

2.1 Mounting the Handgrip

Screw in one 15mm short rod into each of the two receptacles on the front housing of the camera below the lens port. Slide the coupler over the two rods to the desired location and fasten its center wing nut to secure the rods in position. Attach the handgrip to the coupler by mating the star plate on the coupler to that on the handgrip, adjusting to the desired position and fastening the T screw of the handgrip. Connect the Lemo2 cable between the handgrip and camera body to add on/off capability to the handgrip. The Lemo2 connector is located on the battery side of the camera at the front of the accessory box.

2.2 Handgrip On/Off Functions

Both camera run and test functions are available from the handgrip. While hand-holding the camera, pressing the rocker switch to the right provides camera run, pressing the switch to the left provides test. Unlike the body switch, the camera test position of the handgrip is a momentary switch. Pressing and holding the switch opens the shutter and advances the mechanism 1/2 frame. Pressing and immediately releasing this switch advances the mechanism one full frame at a 1/4 sec exposure time. This function allows the use of the handgrip as a simple intervalometer.

2.3 Handgrip Adjustments

The handgrip rotation should be adjusted for maximum handheld operating comfort. Loosen the T screw and rotate the handgrip at the star plate until a more comfortable position is found.

If a more extreme repositioning is required, whether it be for reasons of comfort or clearance in certain studio rig configurations, this can be achieved with coupler extenders, spacers and intermediate arms which utilize the star plate system for adjustment. Ask your agent for a configuration that meets your needs.

In order to use the XTR^{plus} on a standard tripod, the tripod's quick release plate must be fastened to the underside of the camera body with its standard 3/8-16 screw. Make sure to use only a quick release plate screw provided by the manufacturer; non-standard screws longer than 8mm (1/3") can fracture the base casting and damage the camera's electronics.

Shoulder Operation

One of the most attractive features of the Aaton system has always been its comfort and ease of use in handheld situations.

The XTR line does not require the use of shoulder braces or additional padding for handheld operation. The contour of the camera and magazine is designed to fit snugly around the operator's shoulder. The wooden handgrip is attached to the front rod coupler at a slight angle to bring the operator's elbow into his side and increase stability.

The system can be completely built off the 15mm front rods without the use of a bridgeplate to allow for quick changing from shoulder to tripod operating modes.



One often overlooked, yet vital factor in the function and longevity of your camera equipment is your transportation practices. A few good shipping habits can avert potential damage caused by careless messenger services and airport handling.

When shipping and carrying your equipment, it is always good practice to break down the package to its basic components whenever possible. Ship the body, mags and batteries unattached and individually padded. Never, under any circumstances, ship the camera with a lens attached (especially a zoom lens). Shocks transferred from the outside of a case could have disastrous effects to the ultra-critical back focus of a lens and flange focal distance of a camera if transported as one.

Make certain there is ample padding between individual components in a case and from the case's outer edges. Shipping case manufacturers suggest a minimum of 1 1/2" padding between high precision components such as the camera and lenses. 1" of padding is acceptable, however, between some of the more rugged components, such as magazines and batteries. Manufacturers also suggest to allow 2" of padding between the component and the outside of the case.

Choose a case design that, not only meets your shipping and travel requirements, but allows you maximum flexibility and comfort out in the field. Check with your Aaton agent to determine the case configuration that best suits your needs.

Certain precautions should be taken in order to achieve maximum performance when operating the XTRplus in extreme or adverse conditions.

7.1 Cold Weather

One of the cold, hard facts of cold weather shooting is the considerable reduction of battery life. Do whatever possible to conserve your batteries and always carry more than usual. Favor many small batteries, such as on-boards and lithium cells (which are easier to keep warm), over large block batteries. Use a

One often overlooked, yet vital factor in the function and longevity of your camera equipment is your transportation practices. A few good shipping habits can avert potential damage caused by careless messenger services and airport handling.

When shipping and carrying your equipment, it is always good practice to break down the package to its basic components whenever possible. Ship the body, mags and batteries unattached and individually padded. Never, under any circumstances, ship the camera with a lens attached (especially a zoom lens). Shocks transferred from the outside of a case could have disastrous effects to the ultra-critical back focus of a lens and flange focal distance of a camera if transported as one.

Make certain there is ample padding between individual components in a case and from the case's outer edges. Shipping case manufacturers suggest a minimum of 1 1/2" padding between high precision components such as the camera and lenses. 1" of padding is acceptable, however, between some of the more rugged components, such as magazines and batteries. Manufacturers also suggest to allow 2" of padding between the component and the outside of the case.

Choose a case design that, not only meets your shipping and travel requirements, but allows you maximum flexibility and comfort out in the field. Check with your Aaton agent to determine the case configuration that best suits your needs.

Certain precautions should be taken in order to achieve maximum performance when operating the XTRplus in extreme or adverse conditions.

7.1 Cold Weather

One of the cold, hard facts of cold weather shooting is the considerable reduction of battery life. Do whatever possible to conserve your batteries and always carry more than usual. Favor many small batteries, such as on-boards and lithium cells (which are easier to keep warm), over large block batteries. Use a

powercable so that the on-board battery could be kept in a pocket close to the warmth of your body.

When filming outdoors, use a standard or heated Barney to protect the camera body from direct contact with the wind and cold. To avoid condensation inside the mechanism, electronics and lens elements, do not take the equipment indoors or expose it to sudden temperature changes. If and when the equipment must be moved inside, do so by first placing it in a sealed container and letting it thaw for a few hours before opening.

Always keep your raw stock and loaded magazines below freezing temperatures at all times during a cold weather shoot.

The *XTRplus*, as an option, can have its base equipped with a built-in electronic heating element, which is designed to automatically turn on when needed and maintain the claw mechanism at a temperature of 15° F. Contact your Aaton representative for further information.

7.2 Warm Weather

To keep the temperature of the camera body down, avoid having the camera exposed to direct sunlight for long periods of time by using a Barney, all-weather cover, or some form of shading, like an umbrella.

Most importantly, keep raw stock and magazines in a dry cooler or in the coolest location available.

7.3 Humid Conditions

Moist and humid climates are very often the cause for the erratic behavior of any electronic equipment. In order to keep the camera performing normally, care should be taken in such conditions.

A threaded port on the battery side of the *XTRplus* front housing can be fitted with a silica gel caplet, which will protect the most sensitive area of the camera's electronics. Also, transport the camera and other electronic devices in cases containing silica gel pouches and store with the cases closed in the driest location available any time the equipment is not being used.

V

Cleaning

...the
... ..
... ..
... ..
... ..
... ..
... ..
... ..
... ..
... ..
... ..

... ..
... ..
... ..
... ..
... ..
... ..
... ..
... ..

... ..
... ..
... ..
... ..
... ..
... ..
... ..
... ..

... ..
... ..
... ..
... ..

... ..
... ..
... ..
... ..
... ..
... ..
... ..
... ..



Lens Cleaning Tips

Avoid handling lens tissue on the surfaces which will contact the lens. Oil from your hands transferred to the lens surface will make an easy cleaning job tough. Furthermore, never clean a lens element without the aid of cleaning fluid. A good number of scratches on lens surfaces are caused by poor cleaning methods.

1.1 Lens Elements

The front and rear surfaces of your lenses should be inspected regularly and always kept clean of dust particles, smudges, fingerprints etc. First, blow off any large particles of debris using an air syringe. Lens elements should be then cleaned using lens cleaning fluid with lens tissue. Apply a few drops of cleaning fluid to a fresh lens tissue or directly to the lens. Wipe the lens in a circular fashion, starting from the center and working towards the outer edge. Finish with a fresh dry tissue. If some streaking remains, repeat the procedure until the surface is sufficiently clean.

1.2 Lens Exterior

The exterior of your lenses such be cleaned of dirt and adhesives as necessary. Use a multi-purpose cleaner or degreaser such as *De-Solv-It* applied with a Q-tip, lens tissue or cotton cloth.

1.3 Mounting Surface

Always inspect and keep the surfaces of your lens mounts clean using alcohol or a multi-purpose cleaner with a Q-tip. Remember, any debris found on the surface which contacts the lens seat can directly affect the back focus of your lens. Make sure the Q-tip does not leave any cotton fibers behind.

2.1 Exterior

Keep the external body surfaces clean using a cotton cloth with alcohol or a multi-purpose cleaner. Use a utility brush with soft bristles to clean dirt from tight crevices.

2.2 Mounting Surfaces

Like the lens mount, extra care should be taken to keep the lens port ring completely free of dirt and debris. Clean this surface, as well as the threads of the lens lock ring using alcohol or a multi-purpose cleaner applied to a Q-tip.



WARNING

Remember, the camera gate is a sensitive and high precision area directly responsible for the exact focus of the image; be careful not to use hard, damaging materials (like metal) on the its surface. Under no circumstances should you perform any function within the aperture opening, lens port or near the claw with power attached to the camera. Accidentally running the camera while performing such tasks can cause serious damage to the shutter and mechanism.

2.3 Camera Gate

The gate should be cleaned of film particles by means of a pointed wooden or plastic orange stick. The tool used should be of a soft and pliable enough material (like wood) to conform to the grooved side channels of the gate without breaking. Make sure to inspect and clean the left and right channels, the frame of the aperture opening, the lateral pressure plate, the tip of the claw and the timecode LEDs.

Afterwards, run your finger across the left and right rails of the gate, if your hands are clean. The oil from your finger will provide just enough lubricant for the film to pass these surfaces smoothly. Inspect the gate; if the rails are still dirty or are carrying any debris (such as the adhesive from recanned rolls of film), with a Q-tip, use a cleaning fluid that will do the job. Alcohol and lens cleaner are safe to use on the surface of the gate. Make sure the Q-tip does not leave any cotton threads behind.

Viewing System

3

The following components of the viewing system should be cleaned whenever dirt particles are visible through the viewfinder. Use lens fluid applied with a cotton or preferably a foam Q-tip for all areas.

By cleaning the viewing system in the order described below, you will clean the more dust-prone areas first, which may help you track down most dirt particles sooner.

Cleaning the Mirror Shutter

Do not attempt to clean the surface of the mirror shutter; any small dust particles visible from the lens port will not come into focus in your viewfinder. If large particles of dirt must be removed, do so using an air syringe. Never use canned air on this surface.

If the mirror is in need of a deeper cleaning, to remove smudges or oil, take your camera to a qualified technician to be cleaned.

3.1 Viewing Screen / Exterior Surface

Look through the lens port at the reflection of the viewing screen in the mirror and check for visible dust particles. Clear the mirror shutter so that it is rotated safely inside the body by rotating at the base of the shutter by hand or by setting the camera to test position, then remove the battery. Clean the lower surface of the screen.

3.2 Eyepiece

Clean the eye lens (A), which is the outermost element closest to your eye, by first blowing the surface with canned air, then cleaning with lens fluid and a Q-tip. Remove the eyepiece and clean the field lens (B), which is located on the inside of the eyepiece, in the same fashion.

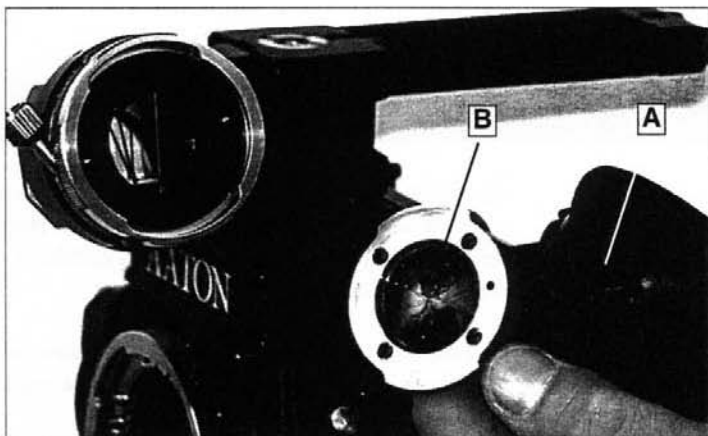

3.3 Viewfinder

With the eyepiece off, look into the remaining viewfinder and clean the exposed element of the pechan prism using canned air or an air syringe. If dirt particles are still present, remove the viewfinder assembly from the camera by removing the four allen screws that hold the base of the viewfinder to the front housing. Clean the exposed element of the viewfinder.

3.4 Viewing Screen / Interior Surface

The last surface to be cleaned also happens to be located in a most delicate area. With the viewfinder off, look into the top cavity of the camera body and visually locate the top interior surface of the viewing screen.

If you shoot with the CCD assist, you will also notice that the retractable beamsplitter will most likely be in place between your eye and the viewing screen. If this is the case, remove the beamsplitter access cap on the battery side of the camera and retract the beamsplitter by rotating the adjustment screw approximately



WARNING

When preparing to clean the top surface of the viewing screen, **never, ever** stick anything down into the top cavity of the body without first being absolutely certain that the beamsplitter is recessed. If you do not feel confident cleaning the screen in this fashion, an alternate means of cleaning is described on the following page.



Finding the Dirt...

There is a simple means of locating much of the dirt within your viewing system:

Look through the viewfinder with no lens on the camera and adjust the diopter ring. If the dust particles remain in focus, they are most likely located on either side of the eyepiece. If the dust comes in and out of focus as the ring is moved, the dust is probably located on either surface of the viewing screen. Furthermore, if the dust appears to be on the same focus plane as the cross hairs of the viewing screen, it is most likely on the bottom surface of the screen and easily accessible.

30 turns clockwise. Double-check that the beamsplitter is fully retracted, giving you access to the top surface of the screen. With lens cleaner applied to a 6 inch wooden Q-tip, reach in and gently clean this surface, making certain to angle the shaft of the Q-tip as far from the edge of the beamsplitter as possible.

The beamsplitter is an extremely thin and fragile glass; any contact whatsoever will most likely break it. Therefore, if this viewing screen surface does not appear dirty or if you do not have the right tools, **do not clean the surface in this fashion.**



There is an alternative means of cleaning this surface which is a bit time-consuming, yet much safer and very effective. By removing the CCD cover and head, as detailed in section 14.7 **Installing the CCD Head**, there is direct access to the top of the screen from the side. Because the beamsplitter sits well above the top surface of the screen, there is no danger whatsoever of contacting it.

4.1 Exterior

Keep the external surface of the magazines clean by wiping down with a cotton cloth with alcohol or a multi-purpose cleaner. When a deeper cleaning is necessary, use *De-Solv-It* rubbed into the mag's surface with a cotton cloth. Finish with alcohol applied with a cloth to restore its original finish.

4.2 Pressure Plates

The magazine pressure plates should be cleaned of dirt and film particles by means of a dust-free cotton or chamois cloth. After cleaning, run your finger across their surface for a slight lubrication.

4.3 Interior / Film Path

Open the doors of the magazine and inspect all surfaces on which the film rides. If any film dust buildup is apparent in the sprocket or roller areas, use alcohol and a Q-tip to clean. Use a utility brush with soft bristles to clean particles from tight crevices. Afterwards, use canned air and thoroughly blow out any remaining dust in the throat and main chambers.

VI

Super16

film the video camera application. The Super16 format is a 16mm film format that is designed for video recording. It is a 16mm film format that is designed for video recording. It is a 16mm film format that is designed for video recording.



1.2. What is Super16? Generally speaking, Super16 can be a good choice in situations where you need a 16mm film format that is designed for video recording. It is a 16mm film format that is designed for video recording. It is a 16mm film format that is designed for video recording.



1.3. Protecting the footage Specific precautions should be taken with the pieces of equipment that contain the footage to protect it against theft. The additional precautions that can be taken to protect the footage from theft are listed below.

1.1 The Format

Super16 is a means of utilizing the cost effectiveness of 16mm film for wide-screen applications. The 1.66 aspect of Super16 uses 20% more of the film surface by extending the picture into an area otherwise reserved for soundtrack or a second set of perforations. This increase in usable area results in significant improvements in image quality obtainable from 16mm film when used for any wide-screen application.

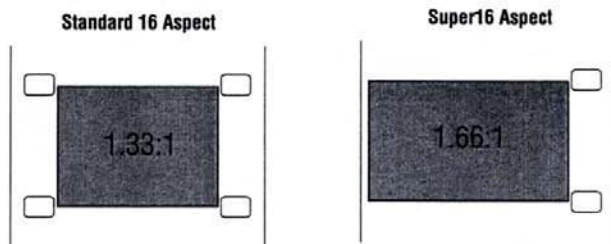

1.2 When to Shoot Super16

Generally speaking, Super16 can be a good choice of origination in the following instances:

- Any low-budget, theatrical production shot in 16mm for blow-up to 35mm.
- Any documentary or film that has the potential for future use in HDTV or some other widescreen aspect.
- Any 16mm production that has a long shelf life or would like to extend the shelf life of their film by making it wide-screen ready.
- Any 16mm commercial, music video or such that will be shown in the letterbox format.

2.1 Protecting the Negative

Specific precautions should be taken with any piece of equipment that handles the Super16 negative. The additional usable area of the film must be free from contact with transportation surfaces in

all instances, whether it be in the camera, at the lab or on the telecine. The Aaton XTR camera series, since its debut in 1984, has been built for safe and trouble-free Super16 operation.

On the other hand, equipment that has not been designed with Super16 in mind may cause rub, scratch or pressure marks within the area once occupied by a second set of perfs. In order to be sure that a certain device is compatible with Super16, it is always best to check with the manufacturer or the facility responsible for the equipment.

2.2 Maintaining High Quality

When Super16 is to be used for 35 blow-up, for future HDTV purposes, or for any other medium of greater resolution than today's standard television, it is of utmost importance to use the appropriate equipment and develop practices that will ensure the high quality of your images. Slight imperfections, which very often pass undetected on an NTSC or PAL screen, are greatly magnified when viewed in a more demanding format.

The *XTRplus*, with a registration tolerance of 1/2000 of the image dimension both laterally and horizontally, delivers the most stable and exact imaging of any 16mm camera available.

Your Super16 images, however, will only be as sharp as the lenses you use to capture those images. It is not enough to choose a lens that merely covers the wider aspect of Super16; just as important are the attributes of a lens such as sharpness, contrast and zoom curve, which affect overall image quality. See the list of recommended lenses for Super16 use, which follows.

The critical adjustment of camera and lens and their relationship to one another insures that the lens is achieving its optimum focus point at precisely the same distance as to where the film plane lies. With the stringent requirements of Super16, it is recommended that camera flange focal distance (FFD) and lens back focus be checked and precisely upheld by a qualified service facility.

2.3 Super16 Compatible Lenses

Lens / Focal Length	T Stop	Min Focus	Format	Mounts
Aspheron - 6.6mm	T1.3	8"	with 12mm only	Aaton, ArriB, PL
Zeiss 9.5mm	T1.3	8"	16 format	Aaton, ArriB, PL
Zeiss 12mm	T1.3	8"	16 format	Aaton, ArriB, PL
Zeiss 18mm	T1.3	10"	16 format	Aaton, ArriB, PL
Zeiss 18mm	T1.3	10"	35 format	PL
Zeiss 25mm	T1.3	10"	16 format	Aaton, ArriB, PL
Zeiss 25mm	T1.3	10"	35 format	PL
Zeiss 35mm	T1.3	14"	35 format	PL
Zeiss 50mm	T1.3	28"	16 format	Aaton, ArriB, PL
Zeiss 50mm	T1.3	28"	35 format	PL
Zeiss 65mm	T1.3	28"	35 format	PL
Zeiss 85mm	T1.3	3'	35 format	PL
Zeiss 135mm	T2.0	5'	35 format	PL
Zeiss 180mm	T3.0	5'	35 format	PL
Nikkor 200mm	T2.0	9'	35 conversion	Aaton, ArriB, PL
Canon 300mm	T2.8	10'	35 conversion	Aaton, ArriB, PL
Canon 30/300	T4.5	10'	35 conversion	Aaton, ArriB, PL
Canon 150/600	T5.6	10'	35 conversion	Aaton, ArriB, PL
Canon 8/64	T2.4	24"	Super16 format	Aaton, ArriB, PL
Cooke 10.4/52	T2.8	18"	Super16 format	Aaton, ArriB, PL
Zeiss 11/110	T2.2	5'	Super16 format	Aaton, ArriB, PL
Canon 11.5/138	T2.5	3.5'	Super16 format	Aaton, ArriB, PL
Angenieux 11.5/138	T2.3	5'	Super16 format	Aaton, ArriB, PL

2.4 Ordering Film

When ordering raw stock from your distributor, make sure to specify **Super16** or **single perf** film. In the US, where 16mm double perf film is manufactured as standard, it is recommended to check stock of Super16 color negative 1-2 weeks prior to shooting. When ordering Super16 black & white stocks, it is advised to contact your distributor a month in advance when possible.

2.5 Film Processing

It is always recommended to choose a film lab that has a certain level of experience handling Super16. Make sure of the services they offer.

When preparing your film to be processed, be sure that your camera assistant has clearly indicated on the film cans and camera reports that the exposed film is Super16.

Shooting Super16

3

One of the most important aspects of shooting Super16 is achieving the full potential quality of the image. The best way to maximize image quality is to reduce the amount of perceptible grain within the picture. Factors such as film selection, exposure and processing techniques will affect the graininess of the resulting image.

3.1 Selecting a Film Stock

Relatively speaking, the faster the stock, the more grain there will be. Therefore, it is recommended to use stocks rated at 200 ASA and below whenever possible.

3.2 Lenses

The characteristics of any given zoom lens, those which determine image quality, contrast and sharpness, are most critical at wide angle and wide open aperture. In order to achieve the best image quality and the greatest depth of field, favor the longer focal lengths and T stops of 4 and above, when possible.

3.3 Lighting

It is recommended not to cut corners with your lighting package for the sake of the budget. Those scenes which rely in the speed of the lens to compensate for minimal lighting will produce more grain than scenes which are amply lit and use a less critical lens aperture (T4 and higher).

3.4 Exposure

When shooting Super16 for blow-up, avoid underexposure and push-processing whenever possible. In fact, slight overexposure of the negative will produce a blow-up with less grain and increase color saturation and detail in shadowed areas. For best results, it is recommended to overexpose the negative anywhere from 1/3 to one stop, depending on the stock and the desired look.

When shooting Super16 for video transfer, slight overexposure is recommended for the same reasons, but care must be taken. Overexposed negatives on a telecine require a higher gain, which increases video noise. The benefits of an overexposed negative, however, outweigh the additional noise introduced if the overexposure is kept within one stop or less.

3.5 Camera Moves

If a Super16 film is to be viewed on a large screen, any camera movement becomes intensified. Therefore, it is best to keep camera moves subtle and handheld activity more controlled than when shooting in 35mm.

Super16 Field Conversions

4

All XTR cameras, including the XTRplus are capable of both 16mm and Super16 operation. These cameras are designed to be field convertible; switchable between formats by the user in a few simple steps. The following section offers detailed instructions on this procedure.

- *For easier identification, the Super16 position of all adjustments will be marked with red dots, standard 16 position will be unmarked.*
- *All references to alignment in these instructions are made looking at the port of the camera from its front, unless otherwise noted.*

4.1 Before You Begin

Before attempting a field conversion, make sure you have the following tools on hand:

- 1 - small slotted screwdriver
- 1 - loupe - approximately 5x magnification.
- 1 - standard metric Allen L-wrench set - sizes delivered with camera
- 1 - orange stick
- 1 - Port Alignment Tool * - part #09-100-62 for Aaton Port, #09-100-61 for PL Port

** There is an alternate means of aligning the port which does not require the use of the Port Alignment Tool. See Step 3 for a description of both methods.*

You'll also need the following equipment:

- 1 - Battery, preferably with XLR4 powercable
- 1 - Zoom lens



The conversion should be performed on a clean workbench or table by an individual who is somewhat mechanically inclined. The entire procedure should take about 45 minutes.

4.2 Procedure

Step 1 - Shifting the Viewing Screen

The XTRplus features a universal viewing screen which is designed to be shifted for use in both 16 and Super16 formats.

- Remove the lens port cover and clear the mirror shutter so that it is rotated safely inside the body and the aperture opening could be seen from the lens port opening. This can be done by rotating at the base of the shutter by hand or by setting the camera to Test position, then removing the battery.

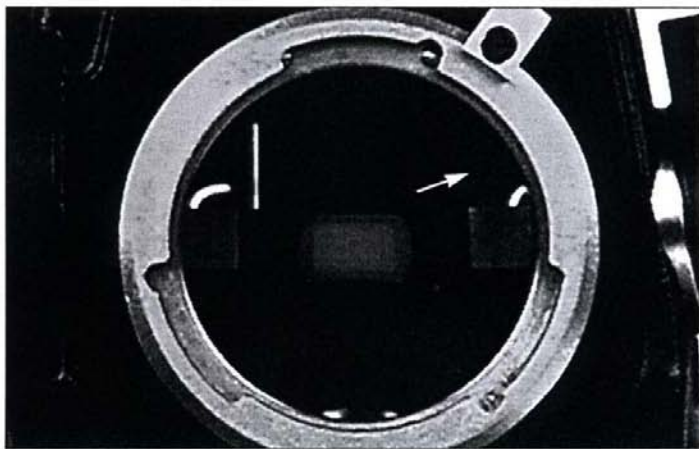

- Locate the small slotted screw to the upper right inside the port opening and loosen the screw 1 turn. In order to shift the viewing screen, place an orange stick at the point indicated in the photo and gently push the screen in the desired direction until it stops.

Standard 16

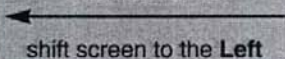

Super16

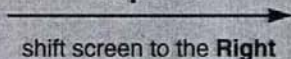

- Secure the viewing screen by tightening the slotted screw until it is snug.

Step 2 - Checking Screen Centering

In order to check your work, you must now confirm that the screen is properly centered to the aperture opening.

- Remove both the port cap and the aperture cover. Power the camera, preferably using a powercable so that a battery is not onboard.
- Open the eyepiece shutter and direct light into the eyepiece by pointing its opening at a desk lamp or an overhead light source.
- Situate the body so that the lens port is angled to face you. Run the camera at normal speed; the opening of the aperture plate should be easy to detect. If this is not the case, place a white piece of paper behind the camera in your field of view.

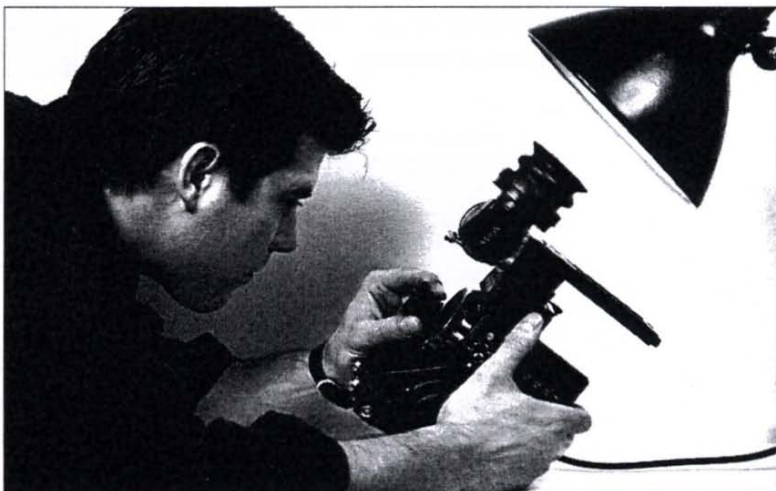

- With a loupe, closely inspect the frame area. If the light through the eyepiece is strong enough, you should be able to see the reflection of the viewing screen superimposed over the aperture opening when the camera is running. If this is not the case, adjust the amount of light through the finder by moving the eyepiece in or out of the light.

- When both the viewing screen and aperture opening can be distinguished, check that the viewing screen image is properly aligned to the aperture opening (indicated below in grey).

For 16 centering, the left edge of the 16 full frame dotted line should meet the left edge of the aperture opening. →

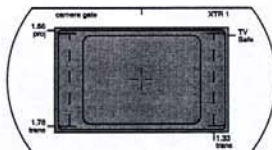
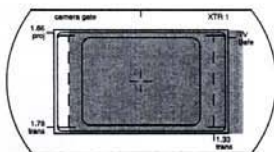

For S16 centering, the entire Super16 full frame should be centered to the entire aperture opening. ←

The tolerance for this alignment is approximately the thickness of a line of the screen. If the viewing screen does not seem to be aligned properly, loosen the viewing screen adjustment screw and try moving the screen again.

Step 3 - Shifting the Viewfinder

The viewing optics of the camera need to be set to the new optical center of the shifted viewing screen.

- Remove the viewfinder assembly from the camera by removing the four allen screws and spacer that hold the base of the viewfinder to the front housing. Take note of the side on which the spacer has been removed. The spacer is used to fill the gap that is created when shifting the viewfinder between formats. Replace the viewfinder assembly accordingly:

Standard 16

shift viewfinder to the **Left**
install spacer on **Right**

Super16

shift viewfinder to the **Right**
install spacer on **Left**

- Secure the viewfinder by installing the spacer on the appropriate side and installing the four screws loosely. After all four screws are in place, tighten each screw until it is snug.

Step 4 - Shifting the Lens Port

The lens port needs to be reset to the new optical center of the shifted viewing screen and viewfinder.

- If the port cap is on, remove it. Remove the lens stop knob by loosening the single slotted or allen screw which secures it to the lens lock ring.

- Remove the lens lock ring by unscrewing it off the lens port ring. Take a look at the lens port ring. Notice that there are three allen head screws which lock the lens port ring to the lens holder, each with an unoccupied hole alongside it. Also note that one of each pair of holes will be marked with a red dot indicating Super16 positioning.

- Remove the three allen screws and carefully lift off the lens port ring and its accompanying shims and place on a clean surface with the shim side face up. Take note of the screw holes from which the three screws have been removed. Also note an unoccupied hole alongside each.



Shifting the Aaton Lens Port of Older Cameras

The lens ports of older Aaton cameras (namely the LTR and XTR series) will have only one set of holes and will not be marked in red. In this case, the flange guides of the lens port ring will have to be rotated to a 7/8 o'clock position for proper Super16 alignment.

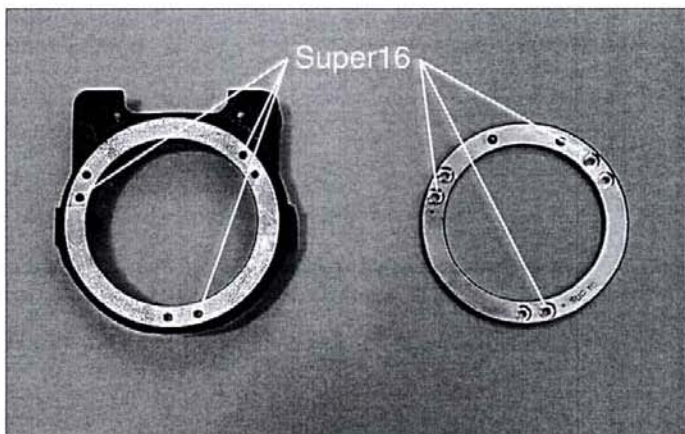

- Shift the lens port by refastening the lens port ring utilizing the second set of screw holes in both the lens port ring and the lens holder.

- Carefully replace the lens port ring and its shims, and install the three allen screws in the appropriate holes as detailed in the diagram. Be sure not to damage the shims; take extra care to align their cutouts around the holes to be used. Fasten the three screws, then loosen each 1/2 a turn in preparation for fine centering.

Step 5 - Fine-Centering of the Lens Port.

There are two methods by which to set the exact centering of the lens to the viewing screen. Both methods are equally acceptable.

Method 1 - via the Port Alignment Tool

*The port alignment tool consists of the **alignment jig** and the **centering rod**.*

- Check that the three allen screws of the lens port ring are loose enough that the ring can move independently of the lens holder.

- Clear the mirror shutter as described in Step 1 so that it is rotated safely inside the body and the aperture opening could be seen from the lens port opening. **Make sure that the battery is removed from the body before proceeding further.**

- Remove the centering rod from the alignment jig and position the jig over the lens port ring with the jig's engravings facing out. Make sure the alignment jig is flush against the surface of the lens port ring.

- While holding the jig in place and looking at the aperture plate, carefully slide the appropriate side (16 / Super16) of the centering rod through the jig and into the port until it peeks through the outside of the aperture plate. If the centering rod is not centered to the aperture plate and cannot slide through its opening, gently move the lens port ring until it can do so.

For **16 centering**, you'll notice that the 16 end of the centering rod is less wide than the aperture and can easily fit in place. In this case, make sure that the right edge of the centering rod is flush against the **right edge** of the aperture opening.

For **Super16 centering**, make sure the Super16 end of the centering rod fits **evenly** through the aperture opening.

- When the centering rod is aligned accordingly, firmly secure the three allen head screws of the lens port ring.

- Replace the lens lock ring by screwing it onto the lens port ring until it stops, then backing it off until the lock stop knob screw hole is at the 2 o'clock position. Install lock stop knob and secure its screw.

- Install the port cap to check that the lens lock ring functions properly.

Method 2 - via Lens Tracking

- Replace the lens lock ring and lock stop knob as described immediately above.

- Check that the three allen screws of the lens port ring are just loose enough that the ring can move independently of the lens holder.

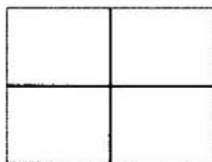

- On a piece of paper, draw a + mark in the center of the page that extends out to its edges so that the page is divided into four equal quadrants. Tape or pin the paper to the ceiling directly above your working surface.

- Position the camera body underneath the paper target with the lens port facing up towards the target. Use a block of wood or a spacer of sorts to position the camera so that the lens port is approximately parallel to the ceiling.

- Select the zoom lens that will be used most frequently with the camera; preferably the lens in your kit with the longest zoom ratio. Mount the lens on the camera and tighten the lens lock ring until the cutouts in the ring give full access to the three allen screws.

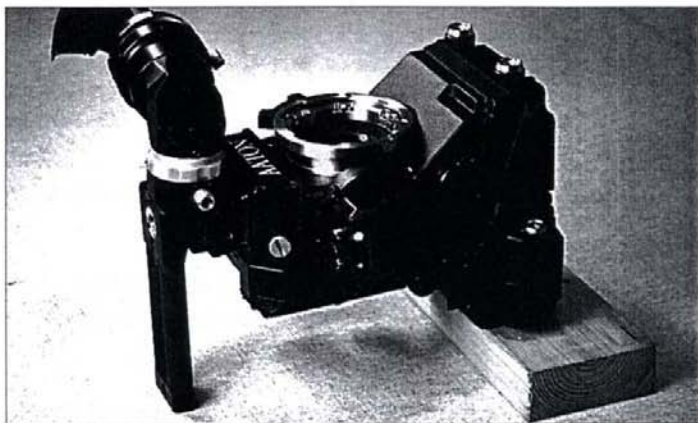

- Look through the viewfinder and set the zoom of the lens to its full telephoto position (the longest focal length). Focus the lens on the target and reposition the camera body so that the center of the viewing screen cross-hair exactly matches the center of the target.

- Set the zoom to complete wide-angle position and notice that the center of the target with relation to the viewing screen cross-hair will track off in one direction. Without moving the camera steady, reposition the lens and lens port ring until the target is centered. Using an allen L wrench, carefully tighten the three screws enough to secure the lens port ring.

- Set the zoom lens to telephoto position and check that the crosses remain centered. If this is not the case, reposition the body, loosen the screws slightly and repeat the above procedure. You will find that, with each adjustment, you will come closer to the correct lens centering.

When the cross on the target matches and holds its center through the entire zoom range, firmly secure the three screws. The target cross should remain within the inside edges of the viewing screen cross-hair to be considered in tolerance through the range.



A Simple and Useful Rule

Always remember one simple rule and you should be able to complete the fine-centering of your Lens Port in a few attempts.

- lens at **telephoto** - reposition the **body**
- lens at **wide** - reposition the **lens**.

Step 6 - Realigning the CCD Assist Target

The CCD assist needs to be repositioned and refocused to be properly aligned to the new optical center.

- Fasten the CCD assist to the camera body by means of three allen screws. Attach a monitor and BNC cable and power the camera and assist. If the monitor has an underscan mode, select it. Because all other elements of the body have already been converted, the CCD image should be soft and off to one side.

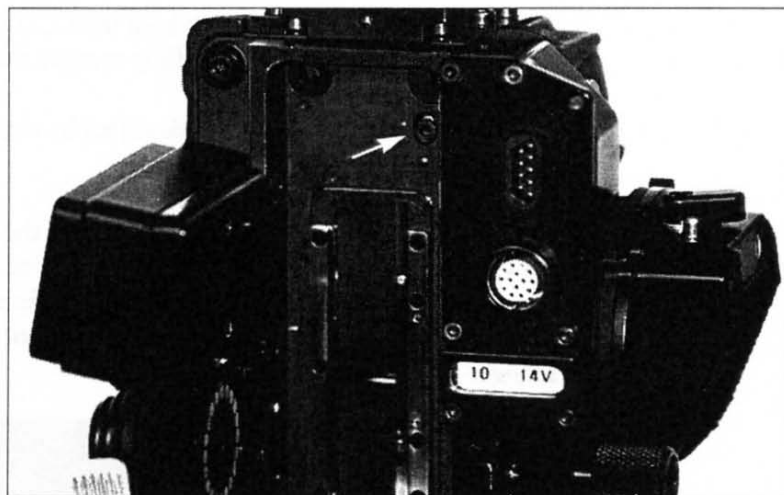

- Locate the beamsplitter axis adjustment, which is to the above / right of the aperture and consists of an allen screw within a slot. Notice a red dot to the upper left of the slot indicating the position of the screw for Super16. Loosen the allen screw 1 turn; while looking at the monitor move the screw within the slot in the appropriate direction until the image of the screen is centered.

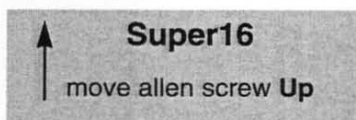
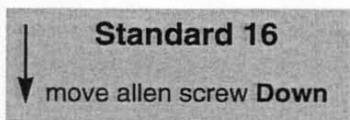

- The resulting CCD image, after this adjustment, should now be centered but slightly out of focus. Follow the next few steps to refocus the CCD head.

- Remove the four screws which hold the CCD cover onto the battery side of the camera. Carefully remove the CCD cover.

- Locate two allen head screws identified by a red dot. Loosen the screws one turn.

- While looking at the monitor, gently move the CCD head until the viewing screen image is in focus. Notice that this adjustment also affects image rotation. When sharp and even focus is achieved and the image is square to the monitor, tighten the two screws.

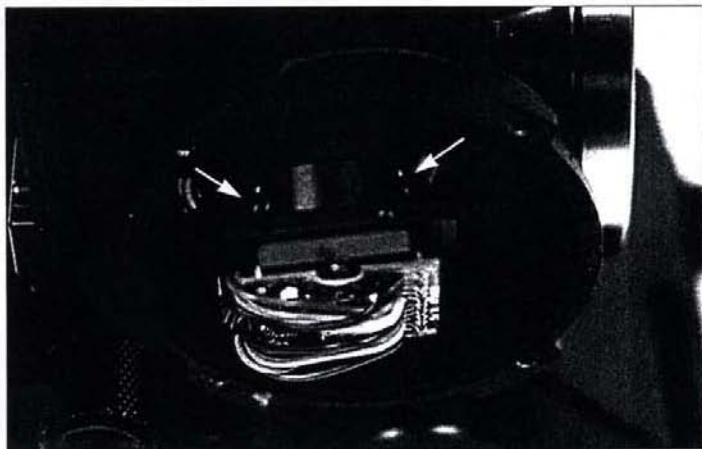

- Locate the iris rod on the CCD head and position it by hand to an upright position. Replace the CCD cover on the body; take care to locate the iris control fork and position it around the iris lever. Tighten the four screws to secure the cover in place. Operate the manual iris lever and check that the CCD iris itself is functioning by looking at the monitor. If the brightness of the image does not change, the iris rod may not be engaged in the control fork. If this is the case, remove the CCD cover and repeat the procedure.

VII

AatonCode

Professionalism is not a luxury, it is a necessity. It is the foundation of a successful career and the key to long-term success. In a world where change is constant, the ability to adapt and learn is essential. This book provides the tools and techniques to help you develop the skills and mindset needed to thrive in a competitive environment. It covers the latest trends in business and technology, and offers practical advice on how to stay ahead of the curve. Whether you are a seasoned professional or just starting out, this book is a must-read for anyone who wants to excel in their field.

The author, a leading expert in the field, draws on years of experience to provide insights and strategies that are both timely and timeless. The book is divided into several sections, each focusing on a different aspect of professional development. From understanding your strengths and weaknesses to mastering the art of negotiation, the author provides a comprehensive guide to success. The book is written in a clear, concise, and engaging style, making it easy to read and understand. It is a valuable resource for anyone who is serious about their career and wants to take their professional life to the next level.

As a professional, you need to be able to think critically and solve problems. This book teaches you how to do that. It provides a framework for analyzing complex situations and making sound decisions. The author also emphasizes the importance of communication and teamwork, and offers tips on how to work effectively with others. The book is a practical guide to professional success, and it is one that you will want to read and refer to again and again.

The author's expertise is evident throughout the book, and the reader can feel confident that the advice provided is sound and reliable. The book is a must-read for anyone who is serious about their career and wants to take their professional life to the next level. It is a valuable resource for anyone who is serious about their career and wants to take their professional life to the next level.

The book is a must-read for anyone who is serious about their career and wants to take their professional life to the next level. It is a valuable resource for anyone who is serious about their career and wants to take their professional life to the next level.

Professionalism is not a luxury, it is a necessity. It is the foundation of a successful career and the key to long-term success. In a world where change is constant, the ability to adapt and learn is essential. This book provides the tools and techniques to help you develop the skills and mindset needed to thrive in a competitive environment. It covers the latest trends in business and technology, and offers practical advice on how to stay ahead of the curve. Whether you are a seasoned professional or just starting out, this book is a must-read for anyone who wants to excel in their field.

The author, a leading expert in the field, draws on years of experience to provide insights and strategies that are both timely and timeless. The book is divided into several sections, each focusing on a different aspect of professional development. From understanding your strengths and weaknesses to mastering the art of negotiation, the author provides a comprehensive guide to success. The book is written in a clear, concise, and engaging style, making it easy to read and understand. It is a valuable resource for anyone who is serious about their career and wants to take their professional life to the next level.

AatonCode, Aaton's proprietary in-camera timecode system, is recorded in the *XTRplus* on the edge of the film between the perforations in both matrix and man-readable form. As recorded in the camera, AatonCode contains a six digit production ID, a SMPTE-compatible real time address (full date and time), a camera equipment ID and the running speed of the body.

Timecode is exposed onto the film by means of seven micro-diodes, which flash rapidly to form the code as the film rolls through the gate. The intensity of the diodes is adjusted to the film's sensitivity by means of the camera's ASA knob.

The *XTRplus* can accept timecode information in both ASCII and SMPTE form, and work with all standard timecode devices. Because the same time address is running in both the camera and the sound recorder, a slate is no longer needed for syncing purposes; synchronization becomes fully automatic during the film/tape transfer or later post-production stage.

An Aaton device called **Keylink**, which consists of CCD reader heads and a PC, and which is owned by the telecine house, is designed to read Keycode and Aatoncode off the film during transfer and correlate this to the continuous video timecode and all other colorist entries for storage on its hard drive. Keylink can also ingest scene/take information and script notes from the set recorded by means of Aaton's **Script Supervisor** software.

The facility can then supply all correlated information in VITC (vertical interval timecode) and/or burn-in windows on the transferred tape, and also on floppy disk for direct use with non-linear editing systems, audio workstations and logging programs.

The *XTRplus* contains an internal clock designed to be initialized from an outside source and keep accurate time (within a half a frame) for 8 hours. The side display of the camera will flash after seven and a half hours of running time to warn that a half hour remains before re-initialization is necessary.

In order for the internal clock to operate, the XTRplus must be powered before initialization. The camera is also equipped with an instantly charged supercapacitor buffer that is designed to keep time between battery changes. Keep in mind that a battery which is too low to run the camera has enough energy to drive the internal clock for hours. Get into the habit of leaving an exhausted battery on-board the camera until you have a fresh battery close by. The supercapacitor allows a full minute for battery replacement before timecode is lost.

OriginCplus

3

For the most efficient and foolproof means of working with AatonCode, it is highly recommended that an Aaton device called OriginCplus is used. OriginCplus can be quickly programmed with a Production ID, full date and time of day, then input into timecode devices in either ASCII or SMPTE form. OriginCplus is TCXO controlled and will run for 150 hours with its internal 9V lithium cell; it is designed to be left on during the shoot day and used as a comparator to monitor timecode drift between devices.

OriginCplus can also be used as a SMPTE generator to supply accurate timecode for slates and inserters, or to record timecode on one audio channel of a non-timecode audio recorder.



Initializing AatonCode in the Camera

4

There are two ways in which AatonCode can be initialized in the XTRplus camera. The preferred method is by means of the OriginCplus, which inputs timecode in ASCII form. It is also

possible for the camera to receive information in SMPTE form directly from a SMPTE timecode device such as an TC audio recorder. Both methods are detailed below.

4.1 Using the OriginCplus - Recommended Method

- Program the OriginCplus by inputting Prod ID, accurate date and time of day. Press the # key to scroll through each field; after all fields are set as desired, Press * to start the clock.

- Make sure the XTRplus has a battery attached.

- Plug the Lemo5 cable of the OriginCplus into Lemo5 chassis mount on the base of the camera. On the XTRplus, the Lemo5 connector is located on the motor side to the lower left of the motor.

- Press * on the OriginCplus to send the timecode information. The OriginCplus will display **Good 00.0** after the timecode has been accepted by the camera. Likewise, the XTRplus will alternately display hours/minutes, then minutes/seconds in its LCD window. Also, the small yellow diode on the camera base will blink to indicate running timecode.

- Make sure to adjust the ASA knob to the exposure index of the film stock being used.

- Disconnect the OriginCplus from the body and proceed to the next device.

For further details on the OriginCplus, please refer to the publication entitled **OriginCplus - Initializing and Monitoring Aaton Timecode.**

4.2 Using an External SMPTE Device

- Make sure the XTRplus has a battery attached and is not running.

- Choose the SMPTE timecode device that will be supplying the timecode (such as a Fostex PD2 or a Nagra IVS-TC). Set the time of day and date, and set its clock to free run mode.

- Connect a cable from the SMPTE output of the timecode device to the Lemo5 chassis mount on the base of the camera.
- Set the on/off switch on the XTR*plus* to test position, then off again; this will send the timecode information to the camera body. The XTR*plus* will alternately display hours/minutes, then minutes/seconds in its LCD window. Also, the small yellow diode on the camera base will blink to indicate running timecode.
- Disconnect the cable from the body and proceed to the next device.

Monitoring and Maintaining AatonCode

5

After initialization, the OriginCplus should be left on during production to act as a visual reference and for quick drift monitoring. Once timecode has been initialized into the camera(s) and sound recorder, accurate time will be individually maintained in each machine for six hours. It is suggested, however, that new timecode be re-initialized after four hours or so as a precautionary measure. Get into the habit of using the OriginCplus to monitor timecode drift in each device when possible; every 2-3 hours or so is recommended.

5.1 Monitoring AatonCode with Origin Cplus

Assuming that the OriginCplus has been left on during the production, follow the simple procedure below to monitor drift in the XTR*plus*.

- Plug the Lemo5 cable of the OriginCplus into the Lemo5 chassis mount connector at the base of the camera.
- Press * to monitor AatonCode drift. OriginCplus will compare the timecode of the XTR*plus* to the code running on its own display. OriginCplus will display **Good**, **fair**, **bad** or **dif-time** (different time) followed by the amount of drift in tenths of a frame.

- Follow the same procedure for each camera or sound recorder on the set running AatonCode.

5.2 Maintaining AatonCode without OriginCplus

If the OriginCplus has not been used and timecode has been set in the XTRplus directly from the TC audio recorder, there is no way to monitor timecode drift between the two devices. In this case, it is recommended to simply re-jam the camera every two to three hours. Follow the procedure detailed in section 4.2

Using an External SMPTE Device

Make sure that the camera on/off is switched to test position to tell the camera to accept the newly fed code.

The Camera Assistant's Duties

6

Although timecode-related practices on the set are very straightforward and uncomplicated, there are a few duties which should be handled by the camera assistant as part of his/her routine.

6.1 Checking the Diodes

In order to inspect and clean the gate between magazine rolls, the camera must be set to test position. Not only will test position rotate the shutter 180°, but the seven timecode LEDs in the gate will illuminate in sequence. Occasionally check that all diodes are operational and are evenly illuminated. As part of the normal gate cleaning procedure, clean this area with a Q-tip and lens cleaning fluid to assure that no dust particles cover the LED array.

The seven diodes will illuminate in test position whether or not timecode is running in the camera.

6.2 Setting the ASA

As an instant reminder, test position, with magazine off the camera, will also display the current setting of the ASA knob. Make sure that the ISO rating of the loaded film matches what is set on the ASA knob. The ASA knob is located to the right of the motor on the motor side.

6.3 Checking for Running Time

The yellow LED located to the right of the motor, will flash once per second on the second when timecode is running in the camera. Get into the habit of looking for this flash as an additional peace of mind check. If more than one camera is counting time on the set, check that all flashes occur simultaneously.

Recommended Film / Audio Selections

7

The following are recommendations for the audio timecode resolving rates to use with specific film speeds under normal operation. For less common situations, (such as filming with sync sound and a separate audio playback, filming live monitors, or resolving with audio from video recorders), consult your Aaton representative or your transfer facility for advice.

Desired Film Speed	Audio Selection
24 fps	Smpte 30 non-drop
25 fps	Smpte 25
30 fps	Smpte 30 non drop

VIII





Technical Specifications

List of Specifications

Weight	6Kg / 13lbs with 400 ft load and 12V on-board battery.
Power	10-14V, 600mA with film at 25°C / 77°F.
Temperature range	-20°C / +4°F to +40°C / +104°F. (-40°C w/ optional electronic heater)
Noise level	20 dB -1 / +2.
Image stability	Co-planar claw and lateral pressure. Vertical and lateral steadiness to 1/2000 of image dimensions.
Speeds	From 3 to 75 fps with independent external speed control. 6, 12, 20, 24, 25, 29.97, 30, 48, 50, 60, 75fps preset sync speeds with 12V.
Formats	16 / Super16 operation. Field-convertible - quick centering of lens axis, viewing system and CCD target between formats.
Viewing screen	Universal fiber optic containing 1.37, 1.78 (16/9), 1.85 aspect ratios.
Viewfinder	Interchangeable finders. Magnif / Ang of view: bellows short eyepiece - 9.5 X / 39° extension eyepiece (20cm) - 9.9 X / 41° hyperlong eyepiece (40cm) - 9.94 X / 42°
Lens port	Interchangeable hard fronts: Aaton universal as standard. ArriPL and Panavision on option.
Shutter	Reflex mirror - fixed 180°.
Lightmeter	Photo-measurement of reflected quantity of light. 1/3 of a stop increments, 4 stop range.

Accessory inputs	Amph9 (video sync), Lemo6 (power zoom), Lemo14 (CCD assist), Lemo5 (SMPTE and ASCII- RS232 time input) and Lemo2 (camera on/off).
Time recording	AatonCode; in-camera, at-the-gate matrix recording of man-readable figures and machine readable data. TCXO control for 1/2 frame accuracy over 8 hours internal clock. SMPTE and ASCII-RS232 in.
Video assist	Black & white - low power (170mA) high sensitivity, integrated CCD assist with manual iris. PAL or NTSC formats. Color - high sensitivity, flicker-free (frame-store in NTSC), integrated CCD assist with timecode windows, video-generated adjustable frame and Vitc insertion. PAL or NTSC formats.
Magazine	400 ft, coaxial instant DX magazine, quick-loading, magnetic drive, no timecode-related parts.
LCD display	ASA selection monitoring, battery voltage monitoring, remaining footage, short end reset, mag ID, timecode readout.
LED indicators	Display camera run, camera test position and low battery.
End-of-film warning	Pre-end and end-of-film warnings via the lightmeter display visible through the viewfinder.

Connector - Pin Attributions

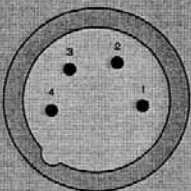
Type	Function	Diagram	Pin Attributions
Lemo2	On/Off/Test	<p><i>as seen from outside of camera body</i></p> 	1 • Ground 2 • Start
Lemo5	Timecode interface		1 • Ground 2 • Smpte In 3 • Ascii In/Out 4 • <i>not used</i> 5 • <i>not used</i>
Lemo6	Accessory		1 • - Batt 4 • + Batt 2 • <i>not used</i> 5 • <i>not used</i> 3 • <i>not used</i> 6 • Start
Amph9	Accessory		1 • - Batt 6 • - Batt 2 • TV Sync 7 • Strobe 3 • 2400 Hz 8 • Start 4 • Ascii In/Out 9 • + Batt 5 • + Batt
XLR-4	Power In		1 • - Batt 2 • <i>not used</i> 3 • <i>not used</i> 4 • + Batt

● - pin

○ - socket