

23/14-105
Canon SUPER 8
AUTO ZOOM 814

INSTRUCTIONS

TECHNICAL DATA

Type: 8mm movie camera using Super 8 film cartridge. Frame size, 4x5.4mm.

Lens: F1.4 with zooming range of 7.5–60mm. 18-element in 13-component composition. Inner diameter, 58mm. Outer diameter, 60mm. Coated in amber, magenta, purple or multilayer coating.

Viewfinder: Single-lens reflex type, combined with built-in prism screen rangefinder. Contains aperture scale, improper exposure indicators, film ending indicator. Eyepiece adjustable with shutter device for preventing rear light entering viewfinder.

EE Mechanism: Automatic aperture setting coupled to film speed and filming speed. Aim the camera at the subject for correct exposure.

Exposure Meter: Through-the-lens system CdS meter measures the light passing through the taking lens. Powered by two 1.3v M20 (#625) mercury batteries.

Light Measuring Range: The entire scale between ASA 250 f/1.4 at 12 fps and ASA 16 f/22 at 24 fps.

Film Speed: Automatically set with insertion of film cartridge. With tungsten type film, ASA 25–250. With daylight type film, ASA 16–160.

CCA Filter: Built in. Corrects colors of tungsten type film in daylight use. Automatically cancelled on insertion of daylight type film cartridge or manually from outside.

Filming Speeds: 12, 18, 24 fps and single frame.

Shutter Release: Three-way switch (safety lock, running position, remote control and running lock position) and shutter lever.

Release Sockets: For remote control, single frame and continuous running photography.

Manual Adjustment of Aperture: Manual operation is possible by releasing the EE mechanism. Fade-ins and fade-outs are possible with the aperture control ring.

Power System: Film drive and power zooming operated by two micromotors. Entire zooming is done in 6–9 seconds.

Power Source: Four 1.5v penlight (size AA) batteries loaded inside the hand grip. Sufficient power for 10 cartridges of film under normal temperature.

Battery Tester: Built in. Indicates power levels of mercury and penlight batteries.

Manual Zooming: Performed by manual zooming lever. Revolving angle of 100°.

Footage Counter: Counts up to 50 feet. Automatically resets when side cover is opened.

Film Transport Indicator: For checking film advancement.

Hand Grip: Folding type containing film-drive battery chamber.

Size: 237 x 107 x 63mm (9³/₈" x 4¹/₄" x 2¹/₂")

Weight: 1,720g (3lb. 12⁵/₈ oz.)

Subject to alterations.

We are highly gratified that you have selected the Canon Auto Zoom 814— a wise choice that promises you many delightful years of photographic experiences. Canon is recognized the world over as the foremost pioneer in the development of photographic equipment of the highest quality and performance. Whether it is for the home, laboratory, or traveling, make the most of your opportunities. A whole new world of home movie enjoyment will be opened to you !



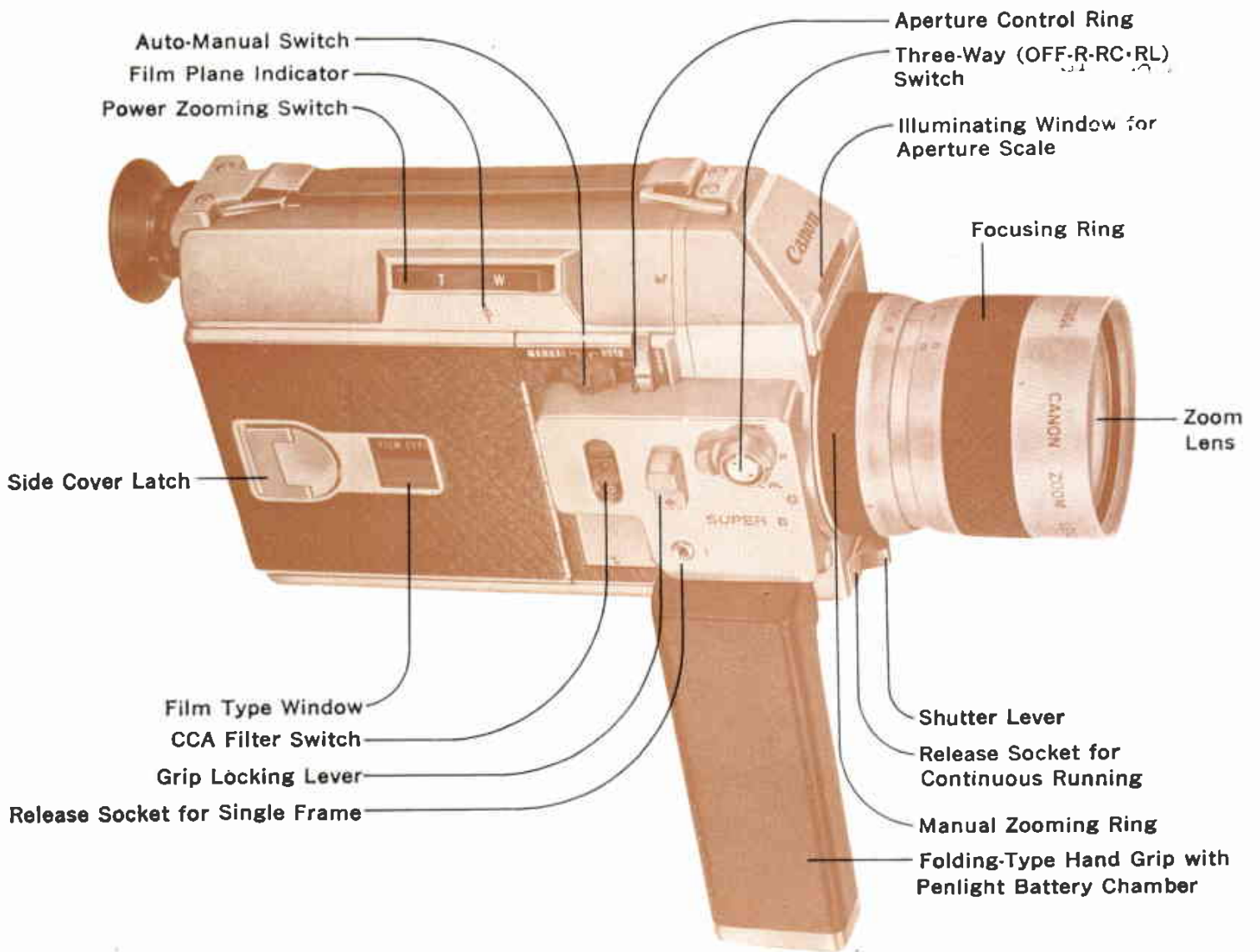

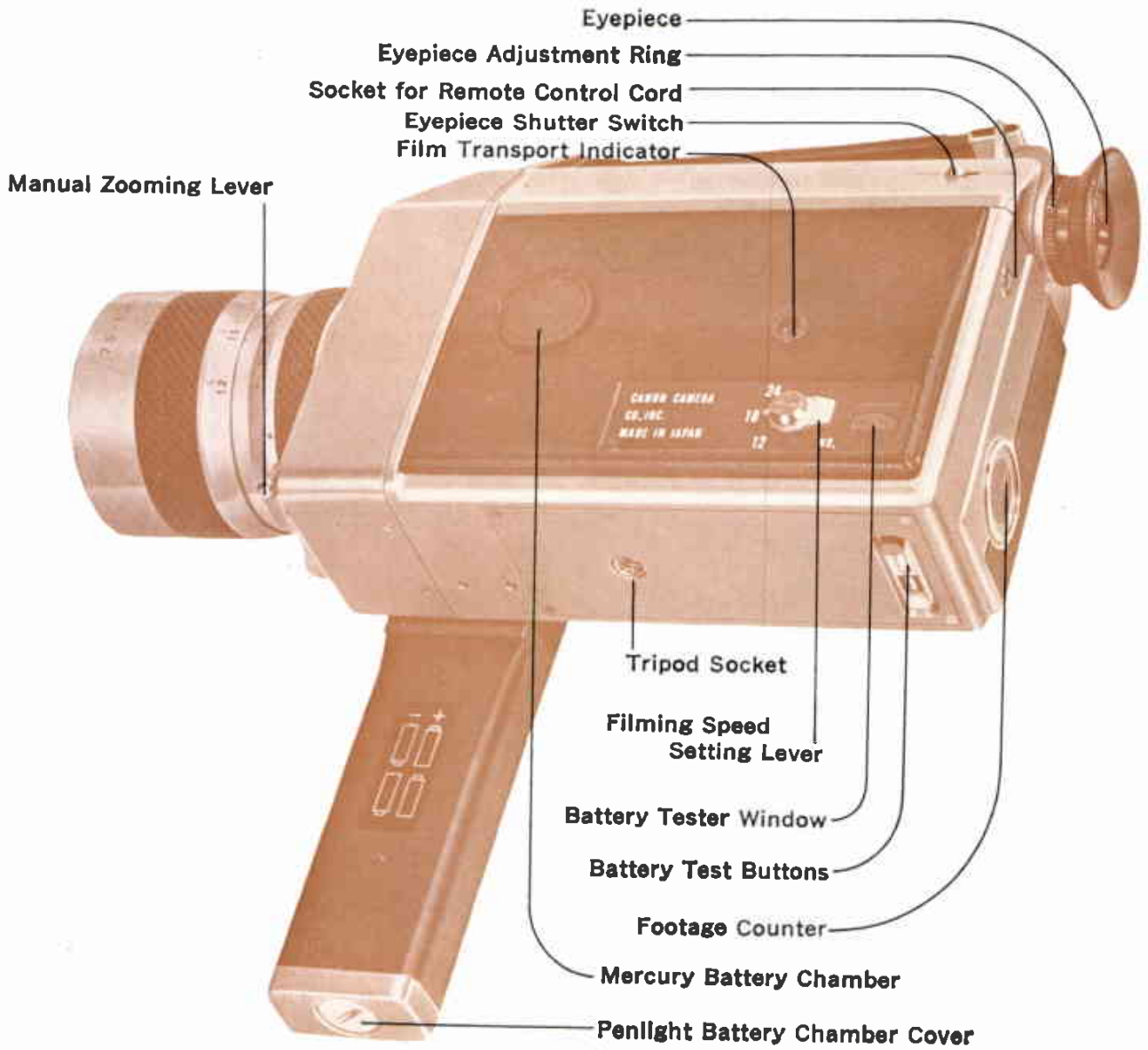

CANON CINE PROJECTOR S-400

Titling Set

Used for titling, close-up photography, copy work and single frame photography. Consists of stanchion, carrying arm, metal fasteners and case.



Canon Chestpod
Remote Control Switch
Lens Hood S-60
Canon Release
Carrying Case

Canon Cine Projector S-400 is the newest and highest quality movie projector. It can automatically load and rewind all 8mm films—Super 8, Single 8 and regular 8mm films up to 400 feet. Operation is very simple. Just insert the film end into the projector, turn the switch, and the film will run completely through and rewind with no need for resetting or touching any other switches. The Cine Projector S-400 has a fast 17–28mm F1.3 zoom lens, 8v 50w mirror lamp, adjustable projecting speeds including slow motion. This projector can be used in any country as it has a choice of seven different voltages from 100 to 240 v.
Size: 333x169x155mm (1' 1 $\frac{1}{8}$ " x 6 $\frac{5}{8}$ " x 6 $\frac{1}{8}$ ")
Weight: 5.2 kg (11 lb. 7 $\frac{3}{8}$ oz.)



MAIN FEATURES OF CANON AUTO ZOOM 814

Eight-Times Zooming on Large Picture Area

The Canon Auto Zoom 814 is the latest 8mm movie camera that can bring out the qualities of the Super 8 film to their highest degree. Picture area of the Super 8 film is 50% larger than regular 8mm film. This film has superb reproduction qualities closely approaching that of a 16mm movie. The combination of the lens speed of F 1.4 and 1 : 8 zoom ratio is one of the most outstanding in the world. The Auto Zoom 814, capable of complete zooming from wide-angle to ultra-telephoto, is an ideal movie camera to take along on picnics, mountain climbing and overseas trips.

Easy Film Loading

Just slip in the entire Super 8 cartridge which holds a continuous 50-foot length of film. No threading or re-loading are necessary. The film speed is automatically set when the cartridge is slipped into the camera.

Built-in CCA Filter

A CCA filter, for converting the color temperature of tungsten type film used in daylight, has been built into the optical system. When shooting under artificial light, the filter can be canceled by the CCA filter switch. When using daylight type film from the beginning, the filter is automatically canceled with the insertion of the cartridge.

Power Zooming and Film Drive

Four 1.5v penlight batteries power the high performance built-in micromotors. Especially, power zooming gives the 1 : 8 zoom ratio its greatest effectiveness and brings variation into your movies.

TTL Type Electric Eye

The electric eye accurately measures the light according to the angle-of-view of the lens, regardless of the zooming range, because of the TTL system in which the CdS meter is positioned on the back side of the lens system. The TTL system also eliminates the necessity of exposure factor compensation when using filters.

Photography by Manual Operation

The aperture can be operated manually by shifting the auto-manual switch to "MANUAL". Fade-ins and fade-outs are possible by the aperture control ring. And with the combined use of an ND filter, fade time can be adjusted.

The Auto Zoom 814 is also equipped with other features necessary for advanced 8mm movie making, such as, running lock, remote control and footage counter. Filming speeds include 12, 18 and 24 fps and single frame.

BASIC STEPS IN PHOTOGRAPHY BY ELECTRIC EYE OPERATION



1

Stand up the hand grip.



2

Load the batteries.

a. For exposure meter: Two 1.3v #625 mercury batteries.

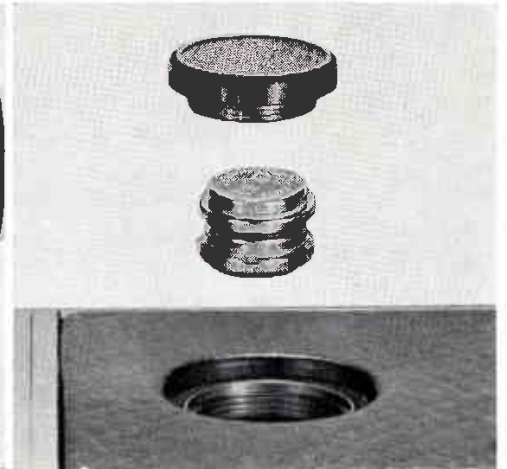

4

Set the auto-manual switch at "AUTO".

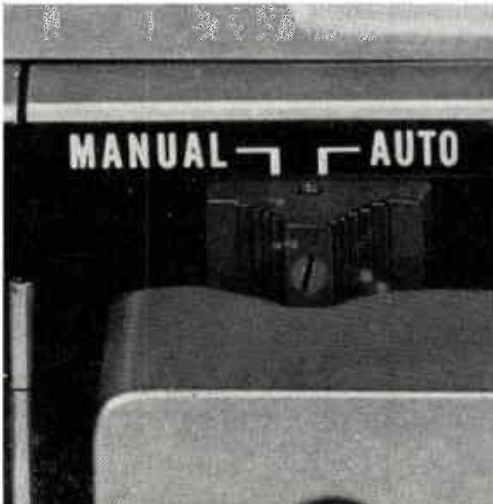

5

Set the black line on the aperture control ring at "O" position.

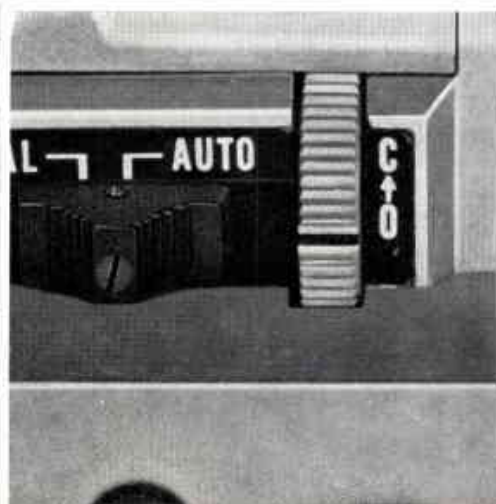

6

Insert a Super 8 film cartridge.



b. For film drive: Four penlight batteries.



c. Check the capacity of the batteries for film drive.



3 Adjust the eyepiece.
a. Open the eyepiece shutter.



b. Make adjustment by turning the eyepiece adjustment ring.



7 Set the filming speed at "18".

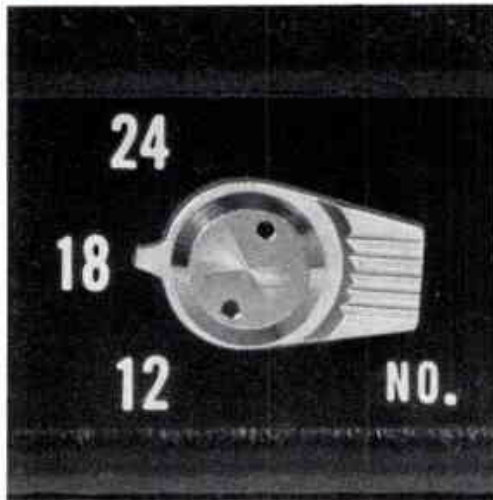

8 Remove the lens cap.

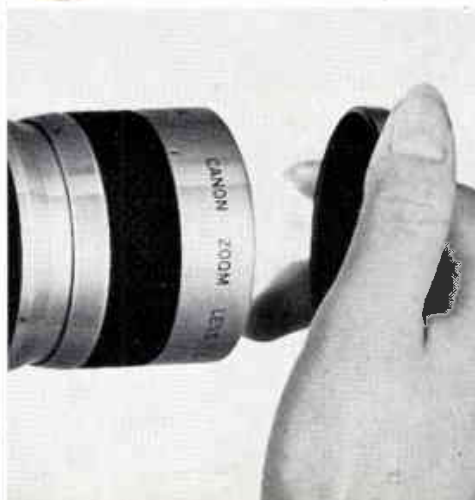

9 Set the three-way switch at "R".

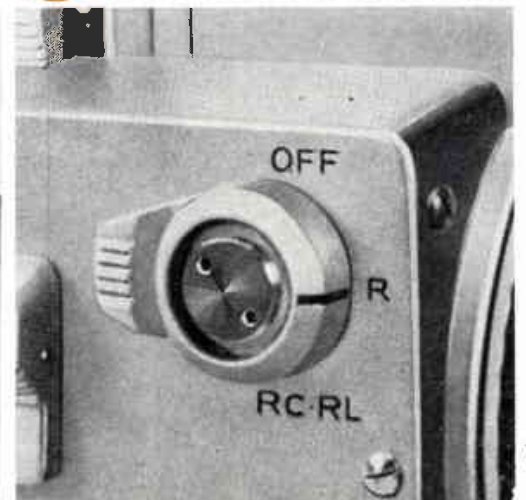

10 Hold the camera and look through the viewfinder.

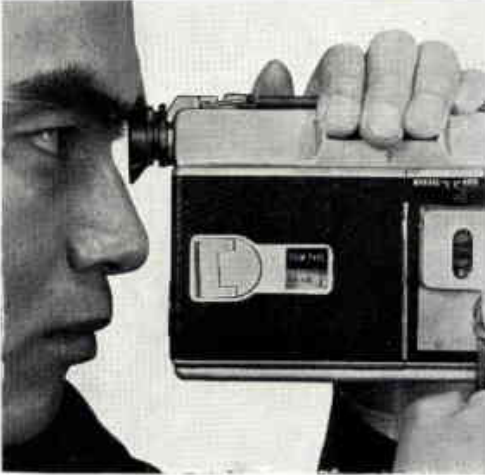

11 Set the focus at maximum magnification (telephoto).



12 Decide the composition of the picture by turning the zoom lens.

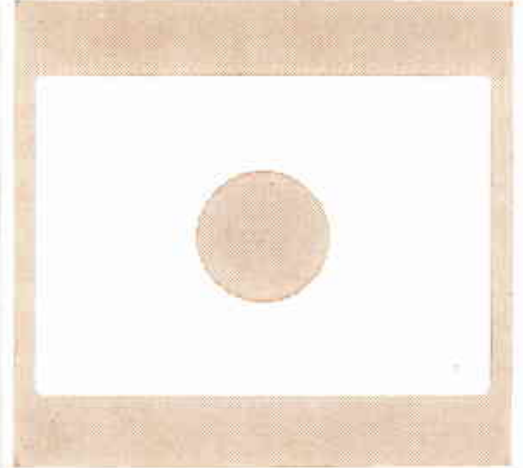

14 Press the shutter lever.



15 During shooting, zoom in and zoom out according to your needs.



16 Take out the cartridge after the entire film has been exposed.



13 Check the position of the exposure meter needle.

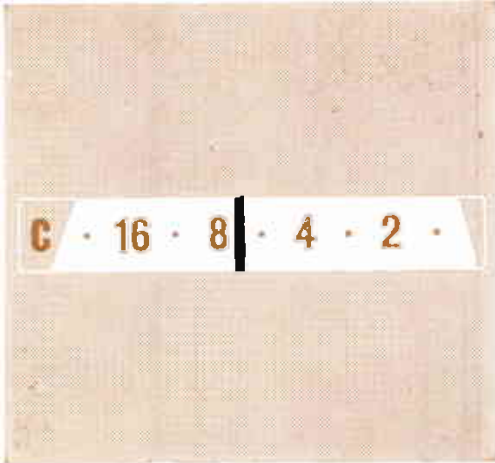

17 Turn the three-way switch to "OFF".



	page
Aperture Adjusting Mechanism	29
Fading Techniques	30
Controlling the Working Range of the Electric Eye	32
Photography by Manual Aperture Operation	32
Shooting with Artificial Light	33
Three-Way (OFF-R-RC-RL) Switch	34
Single Frame Photography and Continuous Running	35
Eyepiece Shutter	35
Panning	36
Proper Care of the Camera	36
Accessories	37
Canon Cine Projector S-400	39

* * *

It is important for you to thoroughly know and to get accustomed to handling the Canon Auto Zoom 814. Please read this instruction booklet carefully, and master the manipulations of the various parts completely before inserting the film cartridge into the camera. If you are thoroughly versed in the correct handling of this movie camera, you can get the maximum performance, such as fade-in, fade-out and zooming, out of the Canon Auto Zoom 814 to your greatest satisfaction.

HANDLING THE SUPER 8 CARTRIDGE AND PHOTOGRAPHY

a The Super 8 film cartridge is loaded with 50-foot length of film. There is no need for flipping over the cartridge in reverse direction halfway through the film. With one cartridge of film you can shoot for approximately 3 minutes 20 seconds at 18 fps.

b Send the exposed film to an authorized developing laboratory. It will be returned to you wound on a reel so that immediate projection is possible.

c The film is of the reversal type in which the positive is obtained. Therefore, the latitude is narrower than negative film. This means you must be especially careful of the exposure when photographing with manually operated aperture.

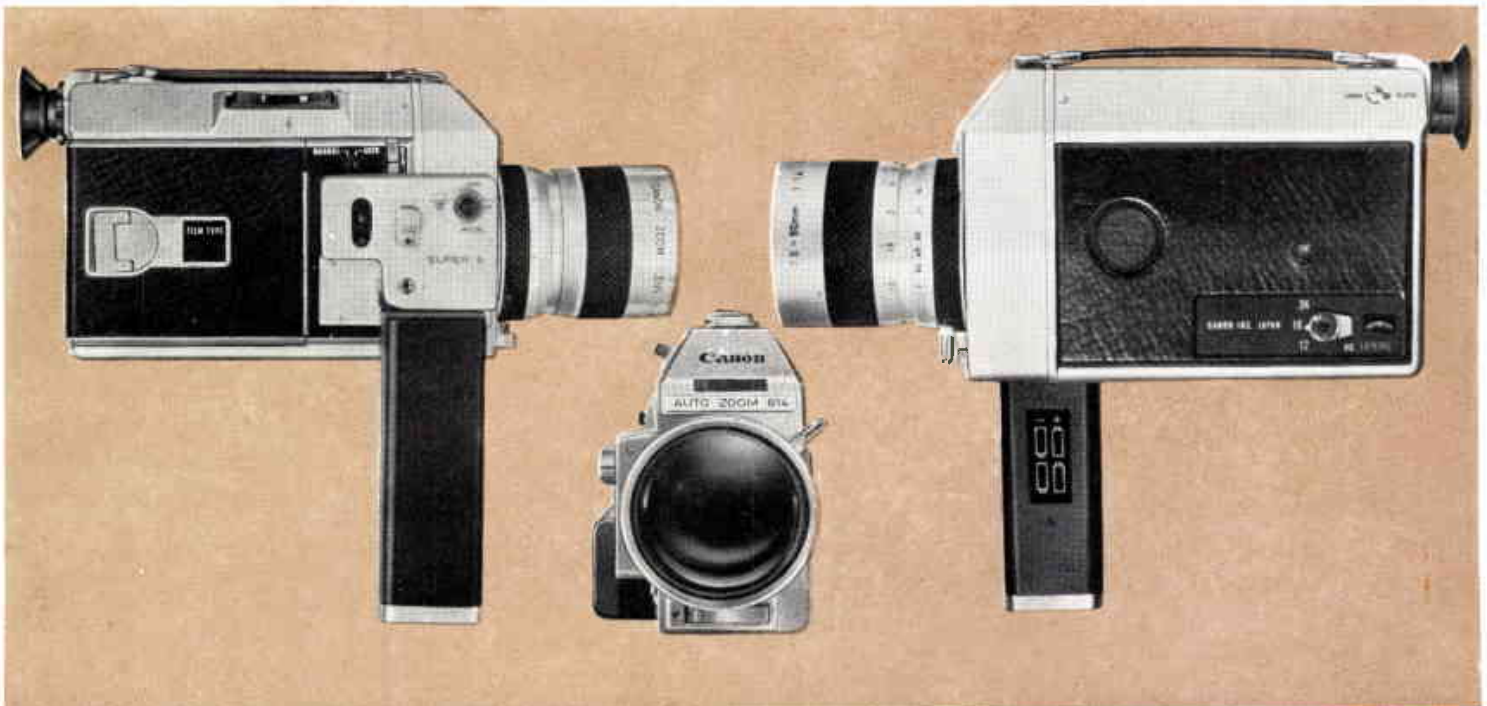

1

HOW TO USE THE HAND GRIP

When the hand grip is stood up it is automatically locked. When folding, keep pressing the grip locking lever upwards and swing the hand grip back. The hand grip also serves as a film-drive battery chamber.

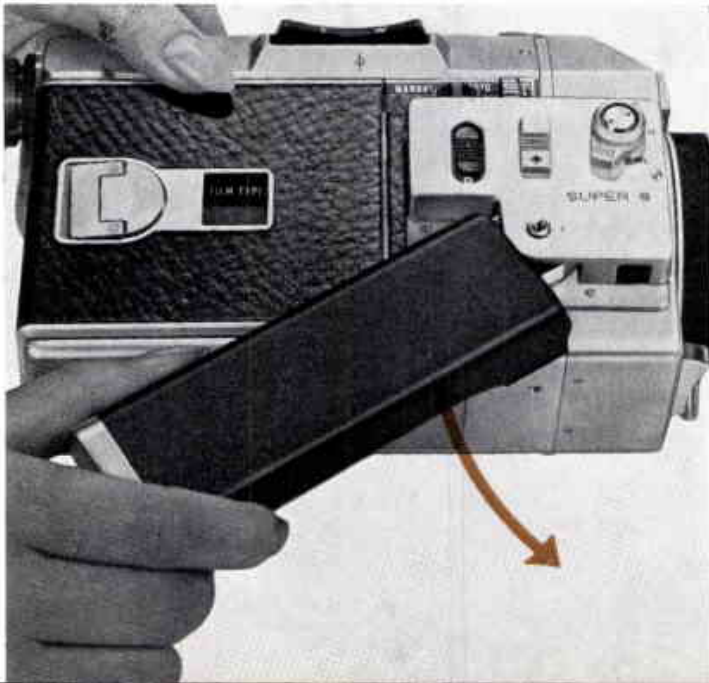

2

LOADING OF BATTERIES

a Mercury Batteries for Electric Eye

Before using your new camera, load it with the two mercury batteries packed in a separate envelope. If the batteries are not inserted, the electric eye will not function.

1. Remove the cover of the mercury battery chamber by turning it to the left.
 2. Wipe the batteries clean, and then insert them with the central contact sides facing inwards.
 3. Screw in the cover by turning it to the right.
- ◆ Use two 1.3v M20 (#625) batteries of the same

make—equivalent to Mallory RM-625R, Eveready E625N, Burgess Hg-625R or National H-D.

◆ Before inserting the mercury batteries into the camera, wipe all poles clean of all fingerprints or stains with a dry cloth. Unclean poles may cause corrosion and damage the contact points of the camera.

◆ Be sure the mercury batteries are inserted in the correct direction by referring to the diagram. Otherwise, the electric eye will not function properly.

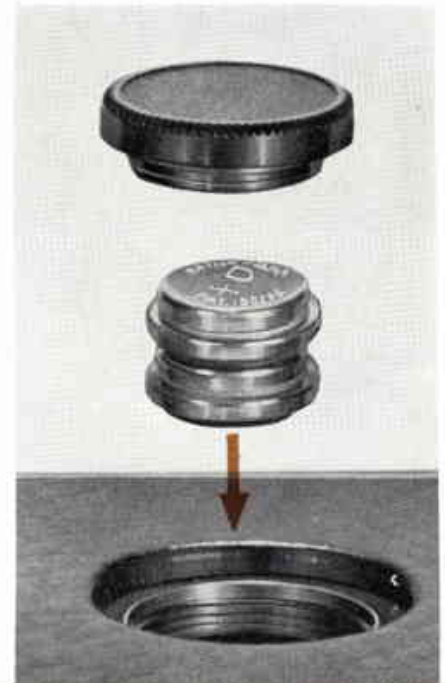

◆ When not using the camera, keep the three-way switch at "OFF".

◆ Be sure to replace the two mercury batteries simultaneously. Life of the mercury batteries in continuous use is approximately one year.

b Penlight Batteries for Film Drive and Power Zoom

Remove the battery magazine chamber cover by turning the screw to the left. Insert the penlight batteries according to the insertion diagram

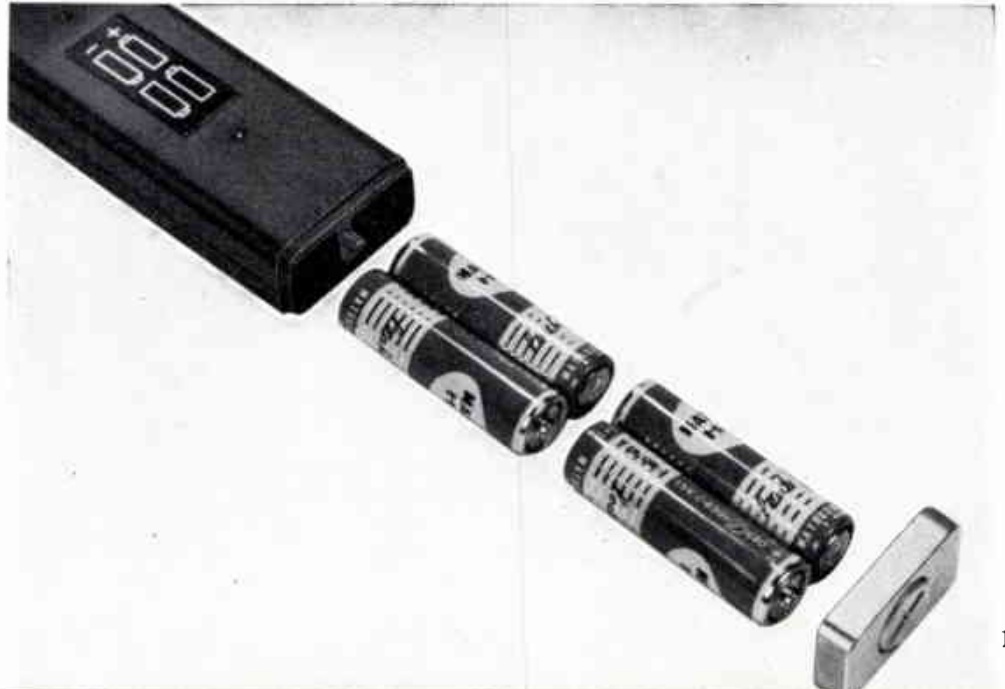
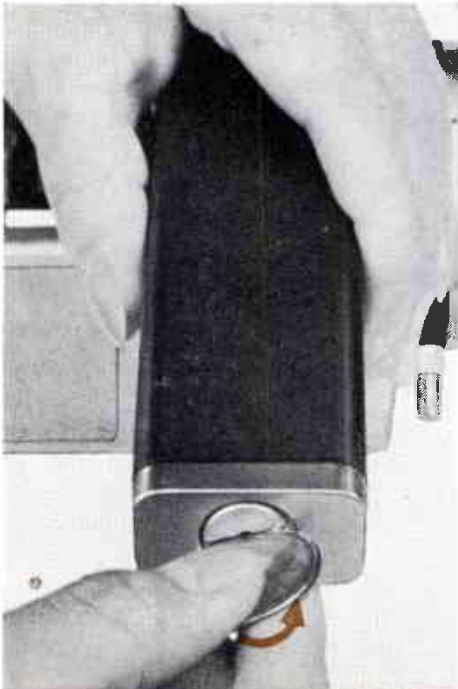

without mistaking the (+) and (-) poles.

◆ Use four 1.5 v penlight (size AA) batteries – equivalent to Mallory M-15P and Eveready #815.

◆ Be sure to replace the four penlight batteries simultaneously.

c Checking the Power Level of Batteries

After the batteries have been loaded, check the power level of the batteries by pressing the battery test buttons at the bottom of the camera.

The white button is for checking the mercury batteries, and the red button is for the penlight batteries. Set the three-way switch at "R", press a button and check the position of the needle seen in the battery tester window. If the needle is in the blue zone, the batteries have sufficient power level. Otherwise, replace the batteries.

▀ If the needle points to the white zone, the penlight batteries have power level for 12 and 18 fps only.

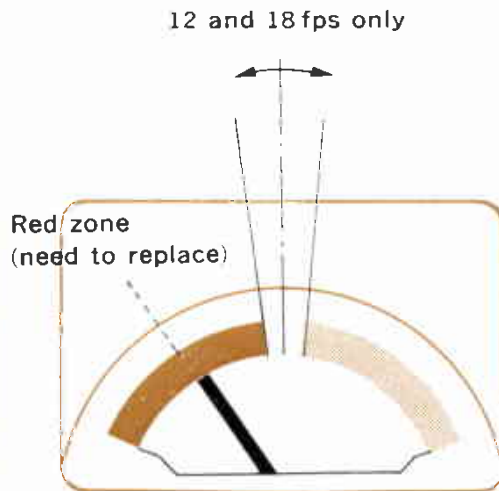
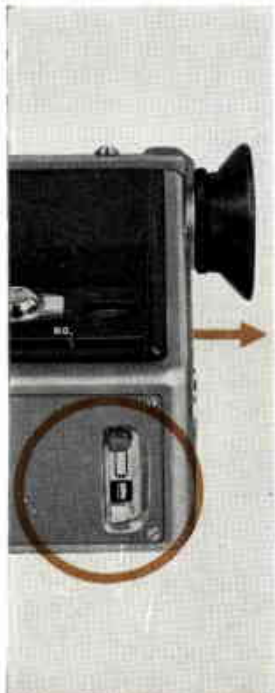

3 EYEPIECE ADJUSTMENT

Loosen the eyepiece adjustment ring by turning it to the left. Aim the camera in the direction of a bright subject and then look into the viewfinder. Turn the eyepiece and adjust it so that the aperture scale and the lines of the prism screen can be clearly seen. Then tighten the eyepiece adjustment ring.



4 SET THE AUTO-MANUAL SWITCH AT "AUTO"

For EE operation, set the auto-manual switch at "AUTO".

▶ The electric eye will not function when the switch is set at "MANUAL".

5 SET THE APERTURE CONTROL RING AT "0"

Turn the aperture control ring and set the black line at "0".

▶ Refer to pp. 29–32 for other uses of the aperture control ring.

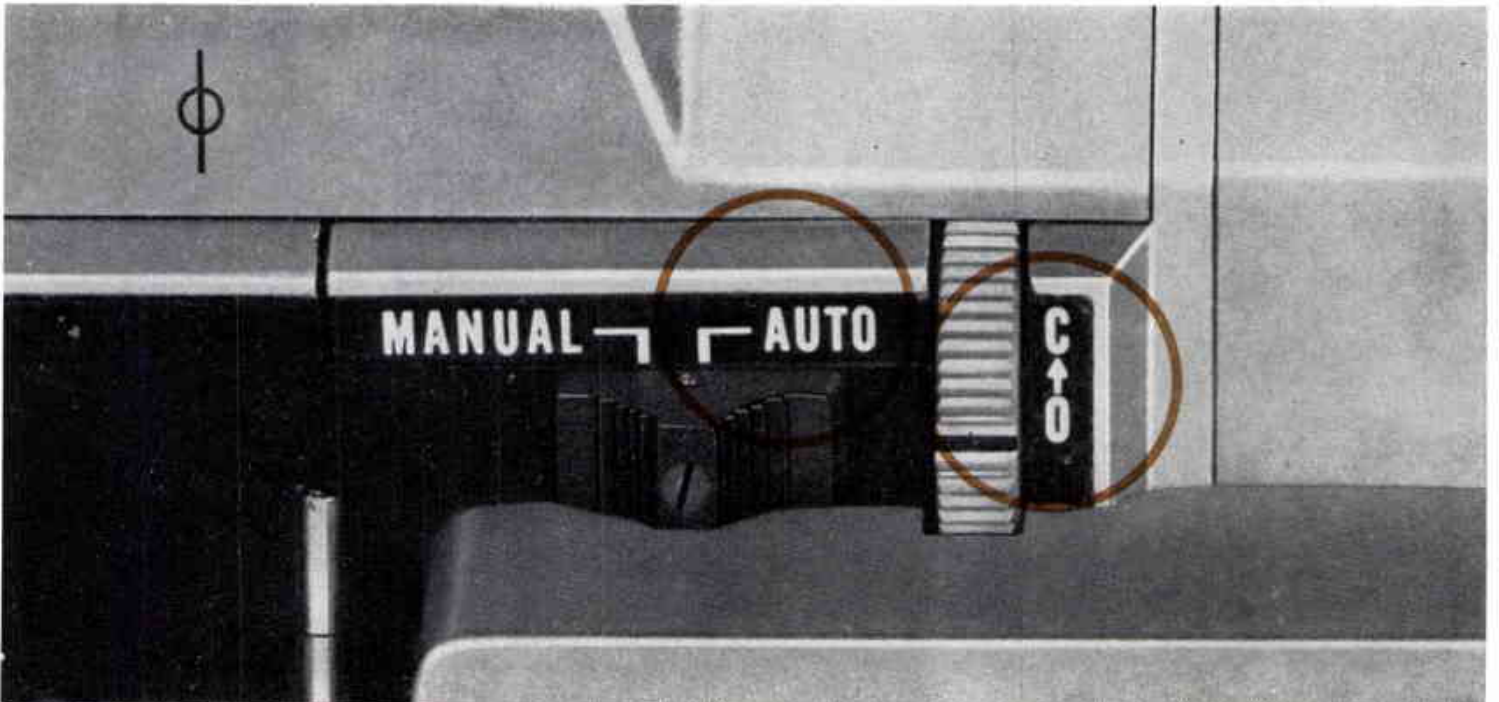

6

LOADING OF FILM CARTRIDGE

a Set the CCA filter switch so that the "sun" mark can be seen. It indicates that the CCA filter is in position.

1. Lift the side cover latch, turn it to the left, and open the side cover.
2. Slide the Super 8 film cartridge in towards the front of the camera, with the label side facing upwards, and then set it into position by lightly pressing down on it.
3. Press down the side cover and turn the side cover latch to the right until it stops.

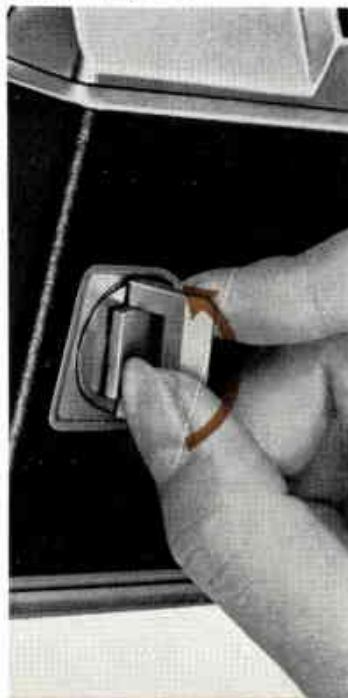
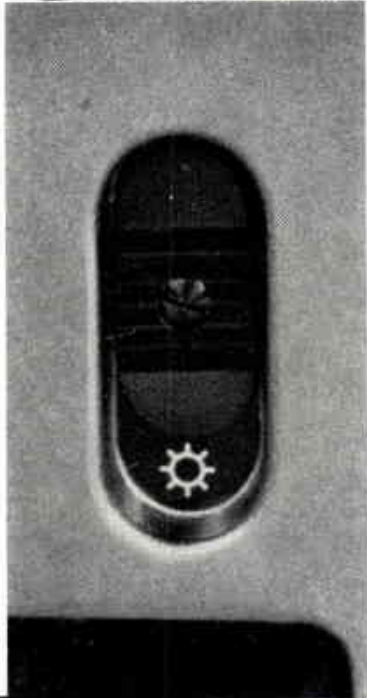

b Set the three-way switch at "R". Press the shutter lever for confirming film advance. If a film winding sound is heard and the white dot in the film transport indicator revolves, it means the cartridge is properly inserted.



C The film speed is automatically set with the insertion of the cartridge. The following film cartridge can be used:

Tungsten type: ASA 25, 32, 40, 50, 64, 80, 100, 125, 160, 200, 250.

Daylight type: ASA 16, 20, 25, 32, 40, 50, 64, 80, 100, 125, 160.

d The footage counter tells you how many feet of film you have exposed. The footage counter automatically resets to "0" when the side cover is opened.

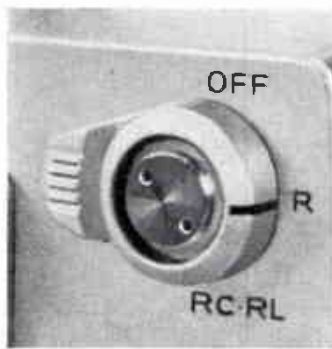

7 SETTING OF FILMING SPEED

18 fps is the standard Super 8 filming speed.
Turn the filming speed setting lever and set it at the desired speed.

a If a movie has been shot at 18 fps and projected at 18 fps, it can be observed most naturally.

b The filming speed of 24 fps is 1.3 times faster than 18 fps and gives a slightly slower motion effect. The exposure time is also shortened. 24 fps is used when making standard sound film, when

extending zooming time or for prevention of blurring during panning.

c The filming speed of 12 fps slightly quickens the movements projected on the screen, and the exposure time is lengthened. 12 fps is used when shooting dark indoors or when stressing the movements of the subject.



24 fps

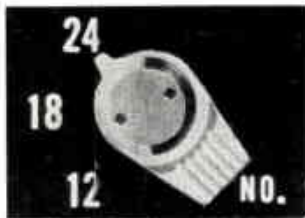

18 fps (Standard)

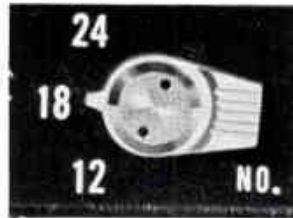

12 fps



8 REMOVE THE LENS CAP

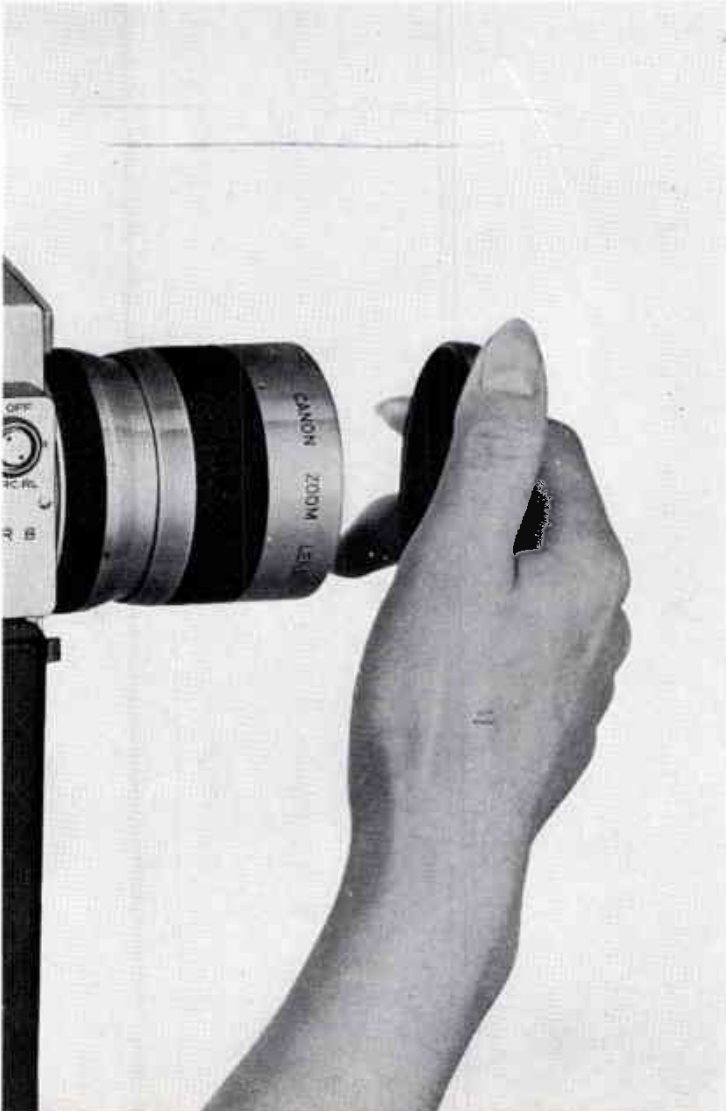

9 TURN THE THREE-WAY SWITCH TO "R"

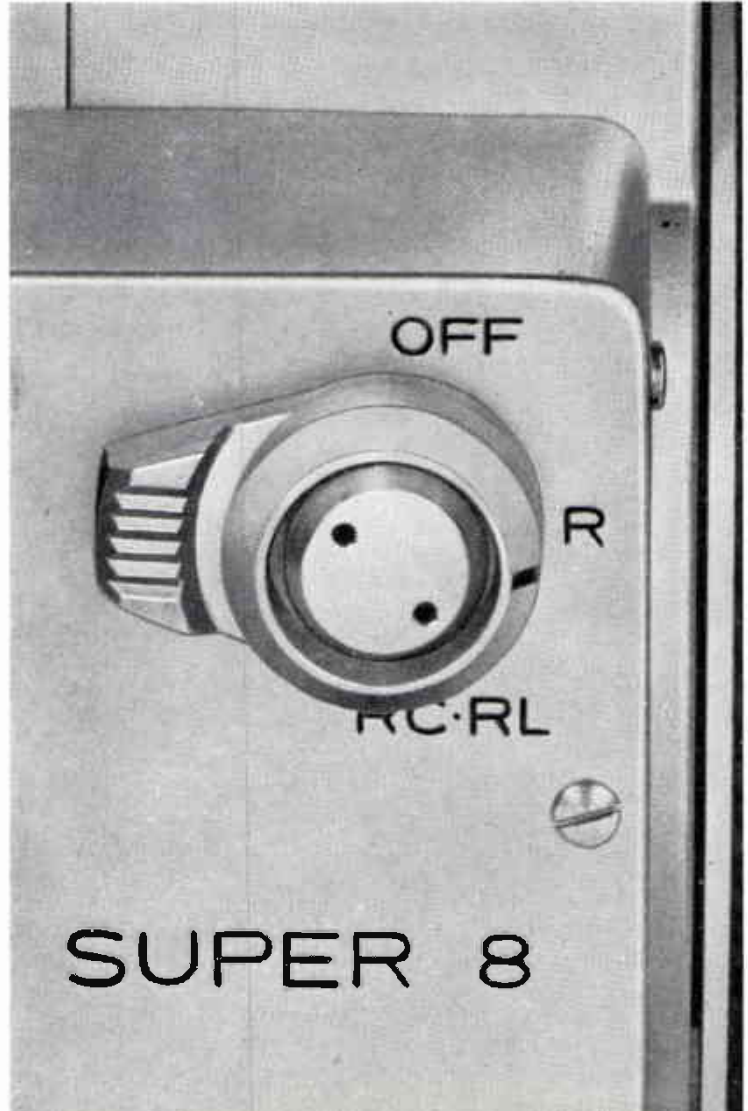

10 LOOK INTO THE VIEWFINDER

a Holding the Camera

Hold the hand grip with the right hand and place the forefinger on the shutter lever. Zooming, focusing and manual aperture adjustments are performed with the left hand.

The camera should be held steady, especially when shooting in telephoto or when zooming. For best results, use a separately available Canon Chestpod or a tripod and cable release when possible.

◆ Be sure the eyepiece shutter switch is set at "OPEN". Otherwise, you will not be able to see anything inside the viewfinder.

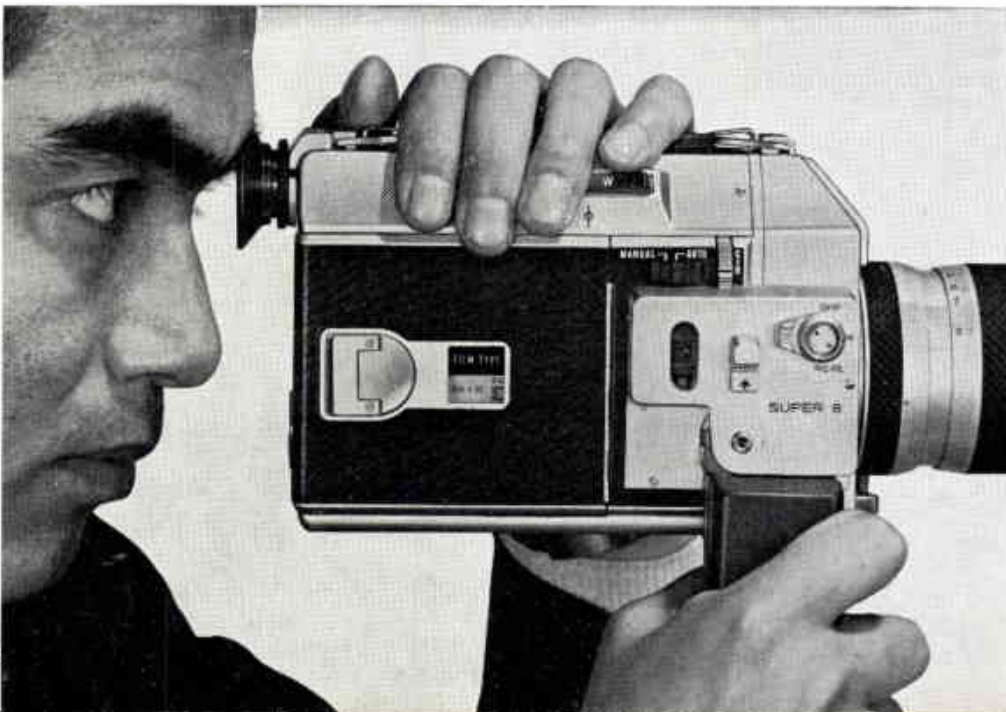

b Canon Chestpod

The Canon Chestpod is used for increasing the stability of the camera and preventing blurring.

With the use of its leg and neck strap the Chestpod firmly holds the camera against the upper part of your body. The Chestpod is especially effective when zooming and shooting in telephoto.

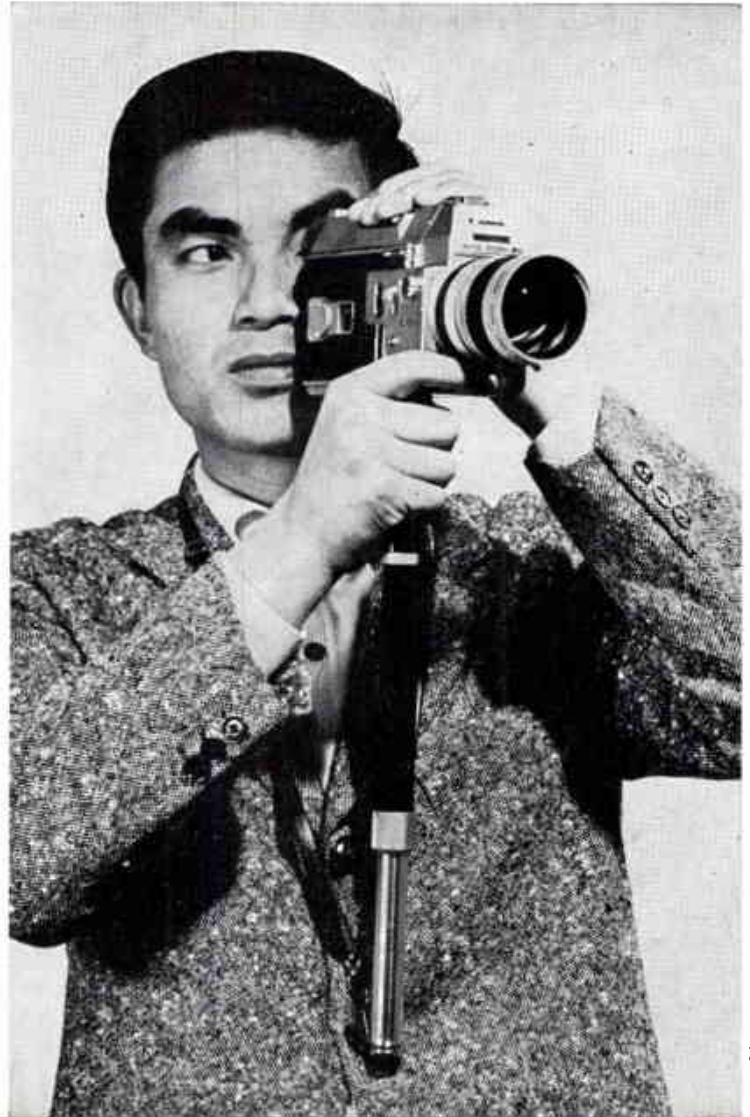
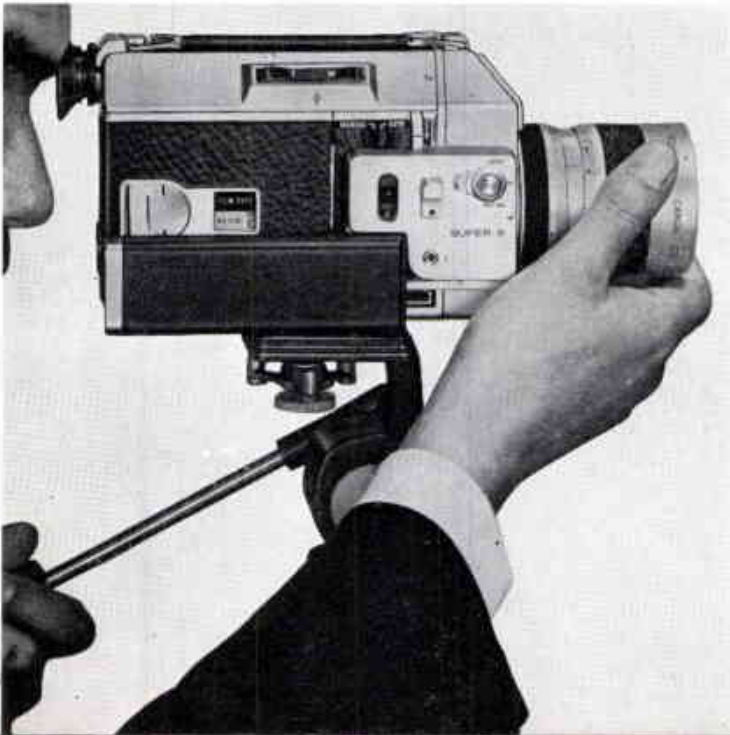

11 FOCUSING

Adjust the focus by turning the focusing ring so that the subject can be seen most clearly through the prism screen rangefinder.

The aligned image can be seen more accurately and easily the longer the focal length of the lens. Therefore, even when you wish to shoot at low magnification (wide-angle), it is advisable to first focus at maximum magnification (telephoto) and then return to low magnification and shoot. The focal point does not change during zooming.

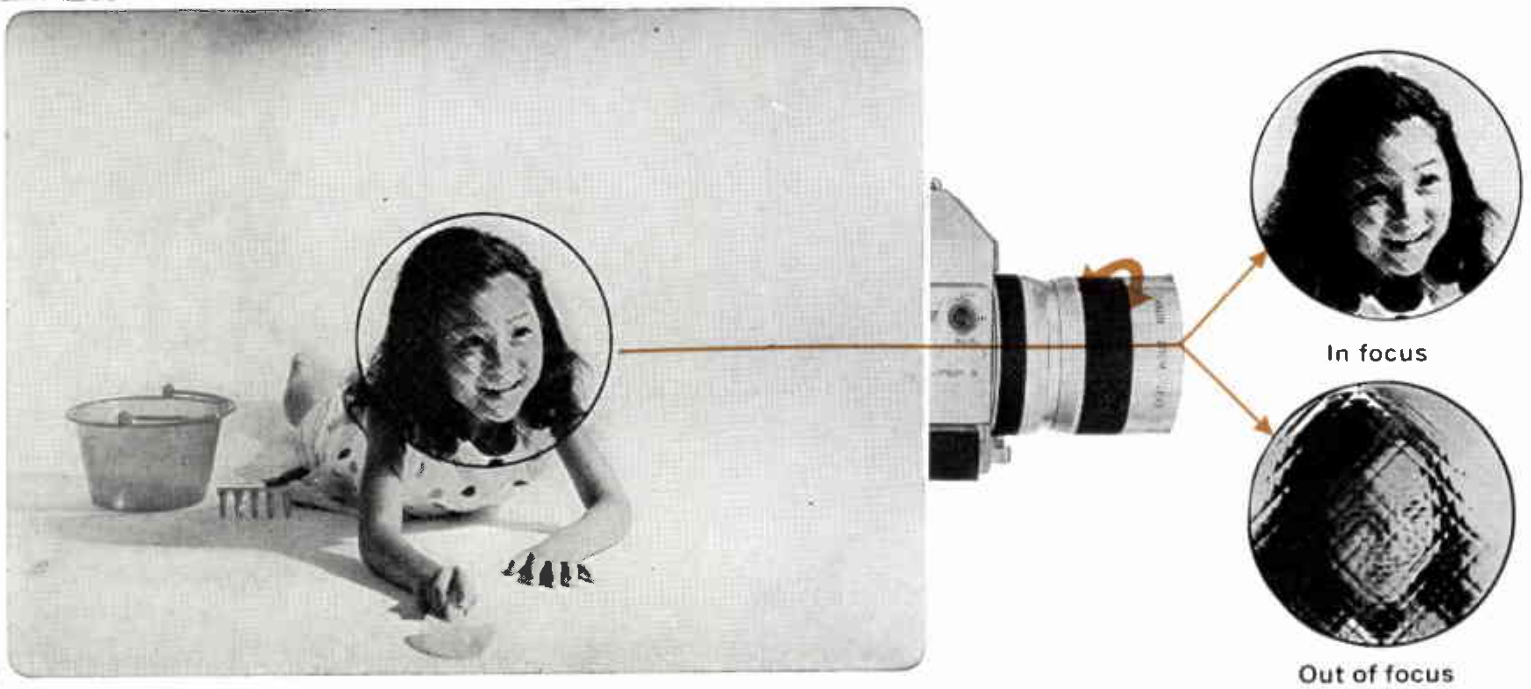

12 DECIDE THE COMPOSITION

The viewfinder of Canon Auto Zoom 814 is of the single-lens reflex type, and so there is no parallax. Thus, the picture area seen through the viewfinder is exactly what will be exposed on the film. The image seen through the viewfinder will change in magnification and the picture area will also change]

by turning the zooming ring. The size of the subject can be decided by zooming.

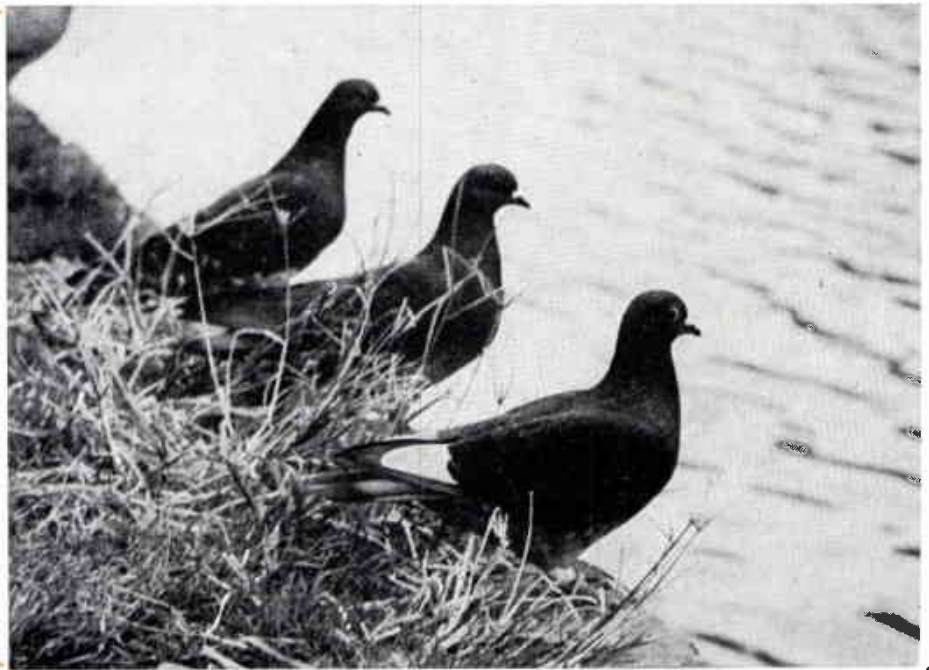
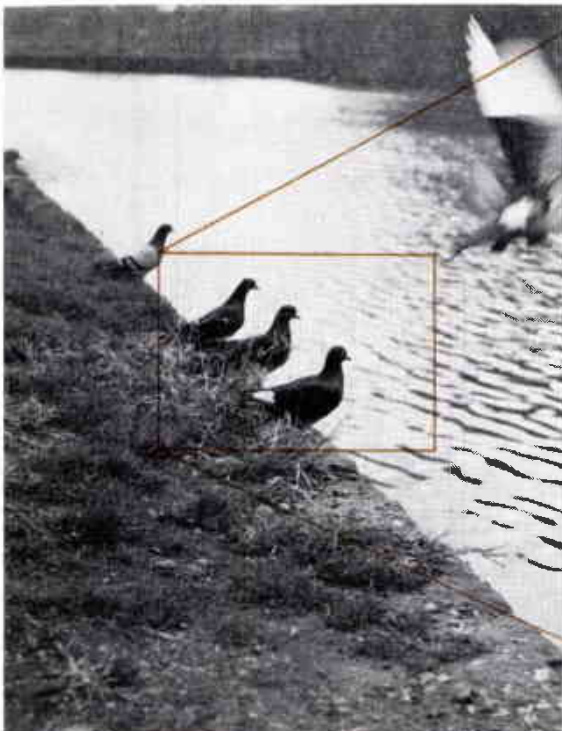

13

CHECK THE EXPOSURE METER NEEDLE

a Before pressing the shutter lever aim the camera at the subject and check the position of the exposure meter needle inside the viewfinder. Press the shutter lever if the needle is pointing inside the range of the aperture scale.

b Exposure with the electric eye is improper if the needle is pointing to either of the red marks on both sides of the aperture scale.

c If the needle is pointing to the mark on the right side it means under-exposure, and so the lighting must be increased.

d If the needle is pointing to the mark on the left side it means over-exposure, and so a neutral density filter must be attached to restrict the light intensity.

◆ Be sure that the three-way switch is set at "R". Otherwise, the meter needle will not move.

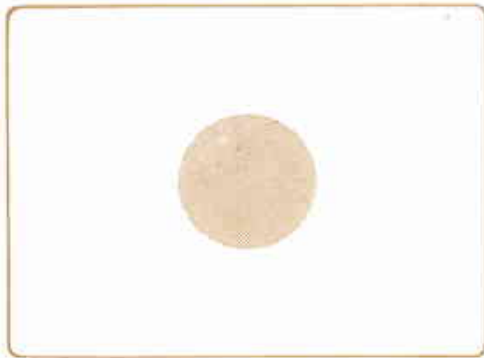

Over-exposure
(Use ND filter)



Proper exposure

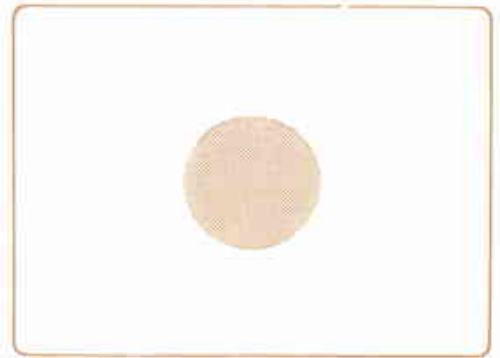

Under-exposure
(Increase the lighting)

14 PRESS THE SHUTTER LEVER

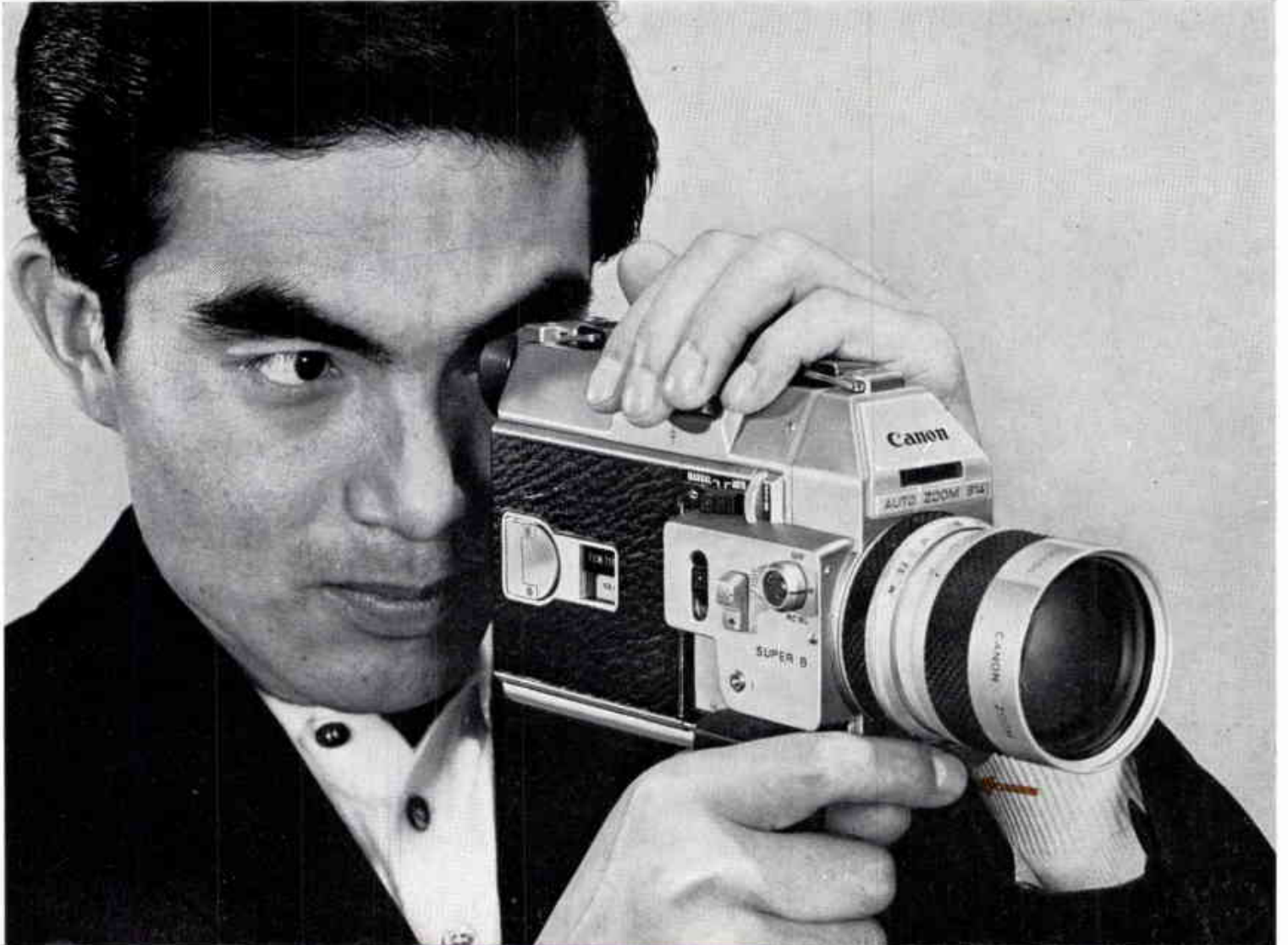

15 ZOOMING

a Power Zooming

Press the power zooming switch for smooth and regulated zoom effects. Zooming towards telephoto is obtained by pressing "T" and towards wide-angle by pressing "W". The entire range of zooming time is 6 to 9 seconds.

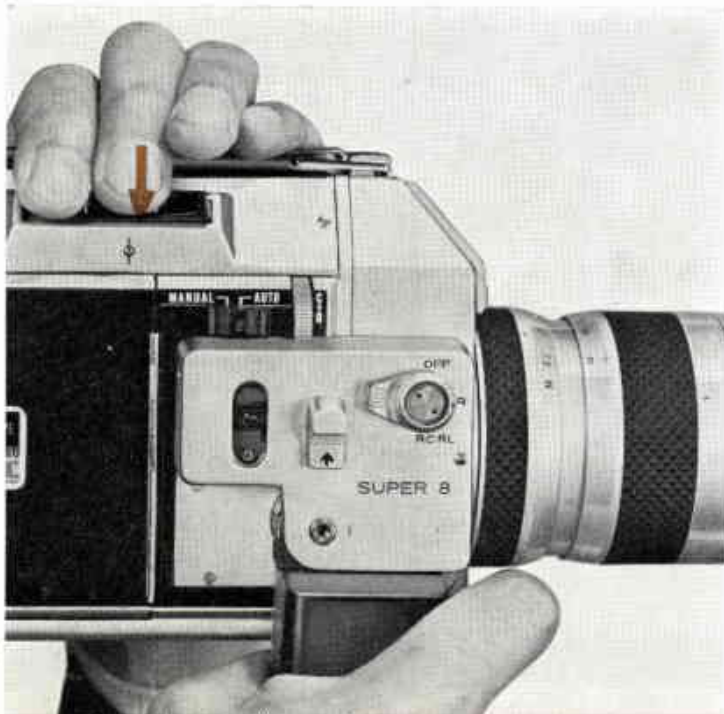

b Manual Zooming

When you wish to zoom faster or slower than at regular speed, or when you want to decide the size of the subject in the picture area, turn the zoom lens by using the manual zoom lever.

◆ The viewfinder magnification is life-size when the focal distance is 12mm.

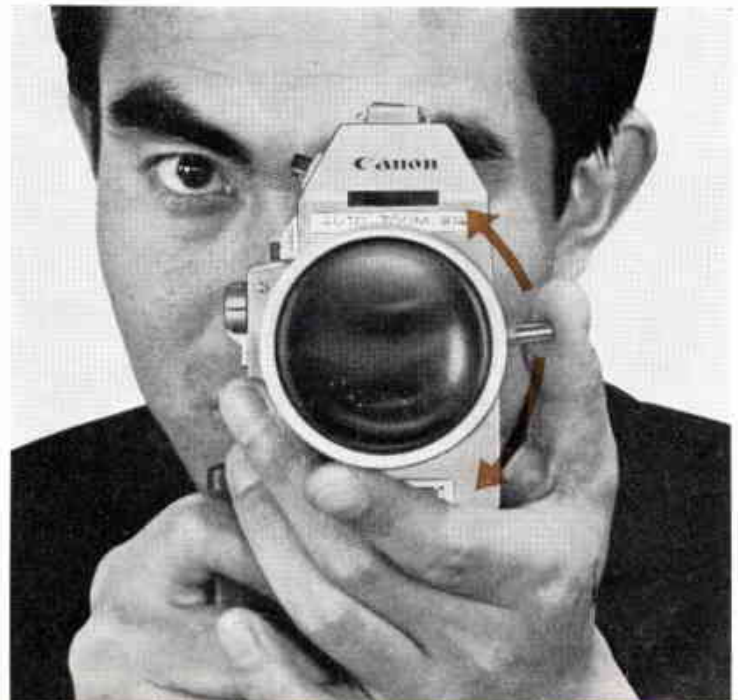



16 UNLOADING OF FILM CARTRIDGE

a Stop shooting when the footage counter reaches "50", and take out the film cartridge. The cartridge contains a 50-foot length of film.

b The aperture scale in the viewfinder is colorless while there is still unexposed film in the cartridge, but changes to orange when the film has been completely exposed or the cartridge is unloaded.



C · 16 · 8 | · 4 · 2 ·

C · 16 · 8 | · 4 · 2 ·

APERTURE ADJUSTING MECHANISM

By turning the aperture control ring the following functions can be performed :

1. In EE operation, the maximum aperture opening can be controlled and the aperture can be closed completely.
2. In manual operation, the aperture can be controlled and closed completely.

By utilizing these functions, special effects such as fading, high-key or low-key can be incorporated into your movie making.

In EE Operation "AUTO"



 EE operation at "O" position.

 Control the aperture opening by turning towards "C" side.

 Aperture is completely closed when fully turned to "C" side.

In Manual Operation "MANUAL"



 Full aperture opening at "O" position.

 Manually set by turning towards "C" side.

 Aperture is completely closed when fully turned to "C" side.



EE functions in the entire range of aperture stop.



EE functions only at a smaller aperture opening than the aperture stop indicated by the needle.



The needle points to "C" (the red mark on the left side).



The needle points to the red mark on the right side



The needle indicates the aperture stop.



The needle points to "C" (the red mark on the left side).

FADING TECHNIQUES

With Canon Auto Zoom 814, you can perform fading techniques in either EE or manual operations by turning the aperture control ring. Fadings are used to show the elapse of time or a change in scene, for instance, when the scene on the stage changes at the end of a theme.

Fade-In

First set the orange line on the aperture control ring at "C" and gradually bring the ring down. As



the ring reached the bottom, i. e., when the black line on the ring reaches "O", the aperture takes over for proper exposure.

Fade-Out

Gradually close the aperture by turning up the aperture control ring to the "C" side while shooting. The picture gradually fades as there is progressive under-exposure until there is no exposure at all. The picture will completely fade-out as the ring reaches the top and the aperture is completely closed.

◆ Fading times of 1–1.5 sec. for a fast changing scene, and 2–3 sec. for a slower changing scene are advisable.

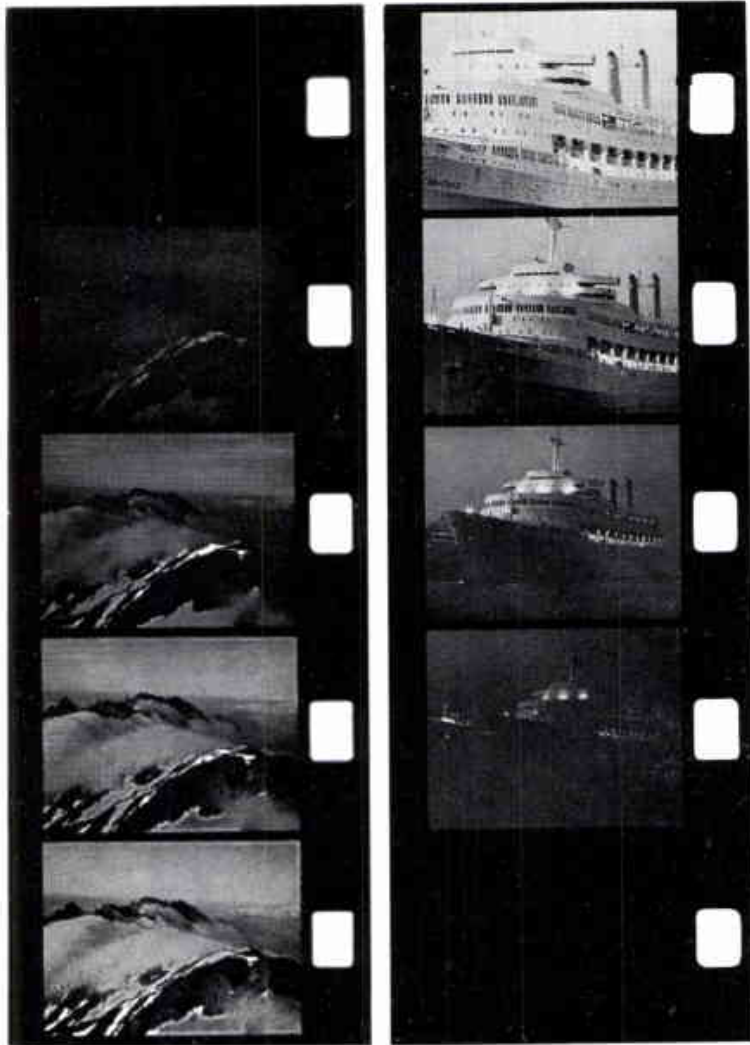

Use ND Filter Under Bright Conditions

The use of a neutral density filter is recommended under very bright conditions or under excess light. Under these conditions, the aperture will close down to $f/16$ or $f/22$, and it makes very little difference with the completely closed aperture, and so fadings will be performed too rapidly. If the light intensity is lowered, with the use of the ND filter, the aperture opening or closing can be performed more slowly and smoothly. Canon ND filters are available in two types, 4X and 8X.

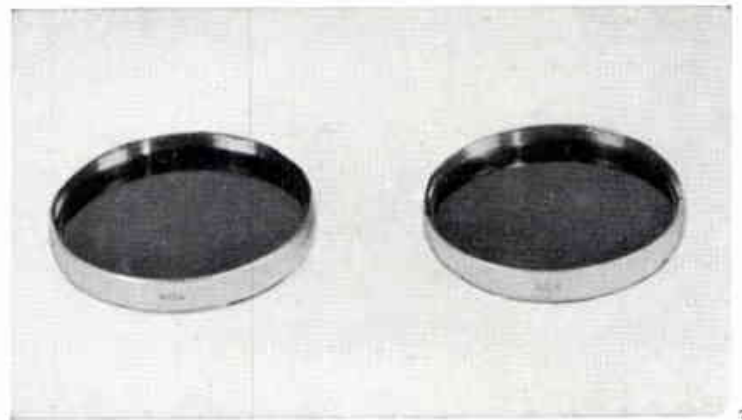

CONTROLLING THE WORKING RANGE OF ELECTRIC EYE

In EE operation, the working range of the electric eye can be controlled so as to perform panning effectively under conditions of extremely bright and dark contrast. The darkness of the dark part is more emphasized while giving the proper exposure on the bright part. It is ideal for panning in a dark room with a spotlighted subject or for panning when including a counter-light part.

By turning the aperture control ring towards "C" the electric eye can be controlled to function only on the smaller aperture opening side than the set aperture stop. For instance, if the aperture is set at $f/4$, the electric eye will function only on the smaller aperture opening side than $f/4$, i.e., $f/4 - f/22$.

PHOTOGRAPHY BY MANUAL APERTURE OPERATION

Photography by manual operation is possible by setting the auto-manual switch at "MANUAL". In manual operation, any desired aperture stop can be set by turning the aperture control ring while looking at the aperture scale inside the viewfinder. Use this method when shooting against the light or when you wish to stress high-key or low-key effects.

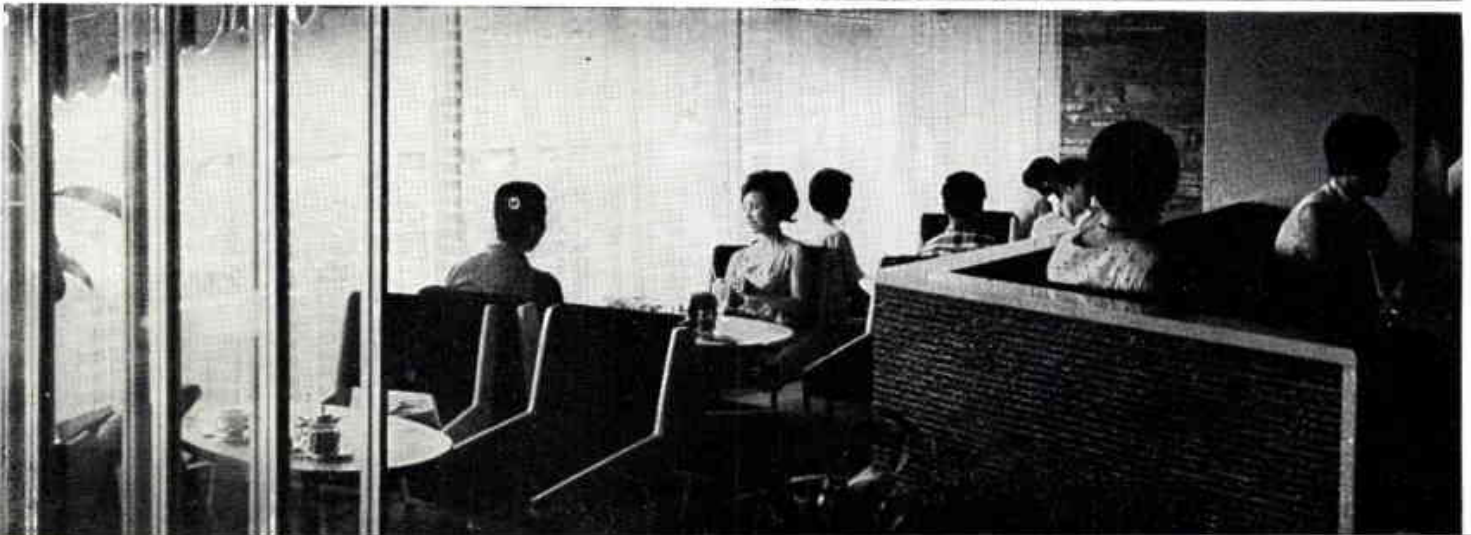

SHOOTING WITH ARTIFICIAL LIGHT

a Your Canon Auto Zoom 814 has a built-in Color Conversion A (CCA) filter so that you can use tungsten type color film, for example, Kodachrome II Type A (KA-II), under daylight conditions. When shooting under artificial light, push the CCA filter switch downwards so that the "bulb" mark appears and the CCA filter is released from the optical system. In this case, shooting under ordinary bulbs (bulbs that are not blue) becomes possible.

b When using daylight type color film, the CCA filter is automatically cancelled by inserting the cartridge and you can shoot under daylight without any switching being made. However, when using daylight type color film under artificial light, a blue bulb must be used or a Color Conversion B (CCB) filter must be attached in front of the lens when ordinary bulbs are used.

◆ When using daylight type film, the CCA filter switch is so designed that it cannot be pushed downwards so that the "bulb" mark appears.

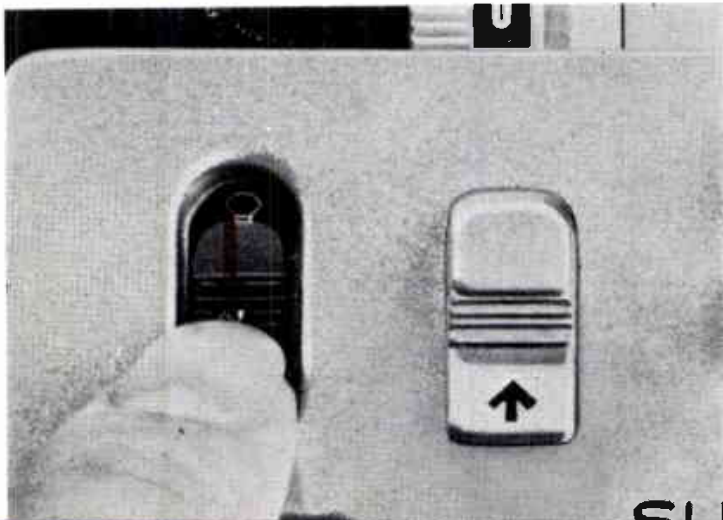

THREE-WAY SWITCH

The three-way switch has three positions of "OFF", "R" and "RC·RL".

1. "OFF" is the position where the power circuit is cut off and the exposure meter, power zoom and shutter release do not function.
2. "R" is where the power circuit is switched on.
3. "RC·RL" is where the running lock and remote control function.

a Running Lock

When the three-way switch is turned from "R" to "RC·RL", while pressing the shutter lever, the lever becomes locked for continued running until the switch is returned to "R" position allowing the lever to pop out, stopping the camera.

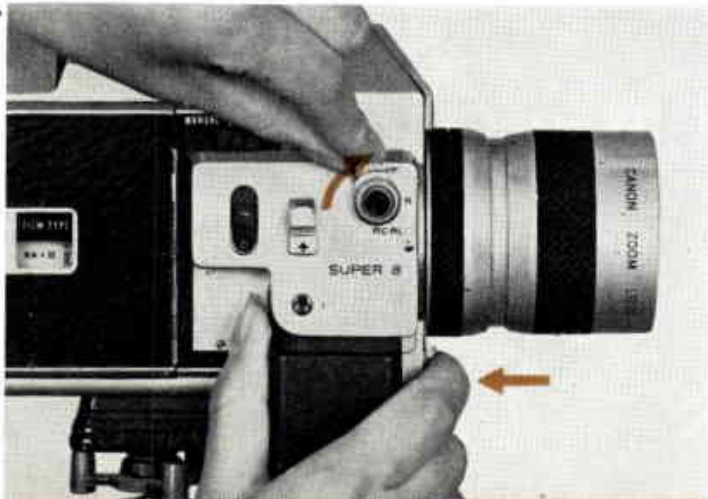

b Remote Control

1. Set the three-way switch at "OFF".
2. Insert the remote control cord into the socket for remote control cord.
3. Turn the three-way switch to "RC·RL" while pressing the shutter lever.
4. Push the knob on the remote control switch in the direction of the arrow. The camera will start to run until the knob on the remote control switch is returned to its former position.

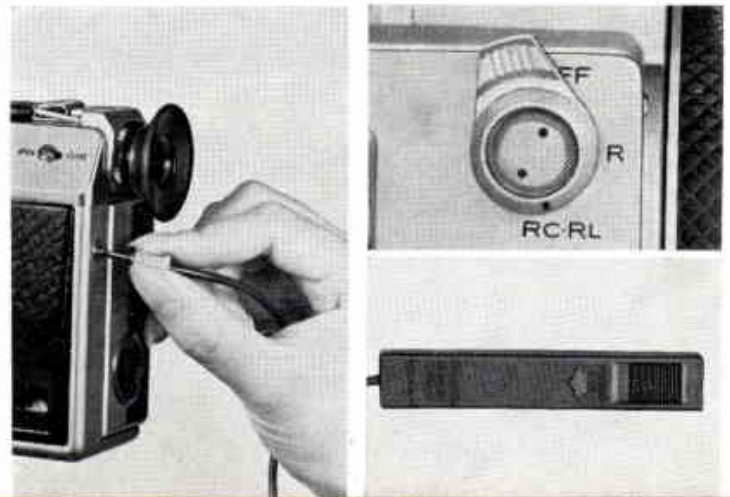

SINGLE FRAME PHOTOGRAPHY AND CONTINUOUS RUNNING

Release Socket for Single Frame

Single frame photography is performed by setting the three-way switch at "R", and by inserting the cable release into the release socket for single frame. Set the filming speed setting lever at 12fps.

Release Socket for Continuous Running

You can use the release socket for continuous running, copy work, titling or when the camera is used on a tripod.

EYEPiece SHUTTER

Be sure to set the eyepiece shutter at "CLOSE" to prevent reverse incoming light when the eye is not against the eyepiece during such photography as panning, single frame and titling. Otherwise, direct light may enter from the eyepiece, flow in reverse direction through the optical system of the viewfinder, and cause ghost images on the film.

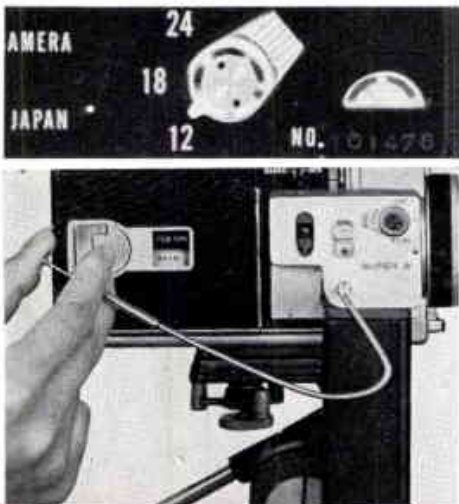

PANNING

Panning is employed when shooting a scene from one position to another by moving the camera around horizontally to make a continuous shot over a wide area in one sequence.

◆ Do not move the camera too rapidly in any direction, particularly vertically. Use of a tripod is recommended.

◆ Panning shots are usually started from subjects of less importance and move on to the most important subject where it ends by running the film longer on the last sequence.

PROPER CARE OF THE CAMERA

1. Do not put fingerprints and other stains on the zoom lens. Wipe gently with silicon cloth when removing stains and use a blower for removing dust.
2. It is important that the aperture section, through which the film passes, always be kept clean by blowing the dust away with a blower. Do not use anything hard such as a metal brush.
3. Keep the camera away from moisture, heat and dust when storing. Do not keep camphor or naphthalene near the camera.
4. Be sure to set the three-way switch at "OFF" when putting the camera into its case.
5. When the camera is not to be used for a prolonged period of time, remove the batteries and keep them in a dry place.

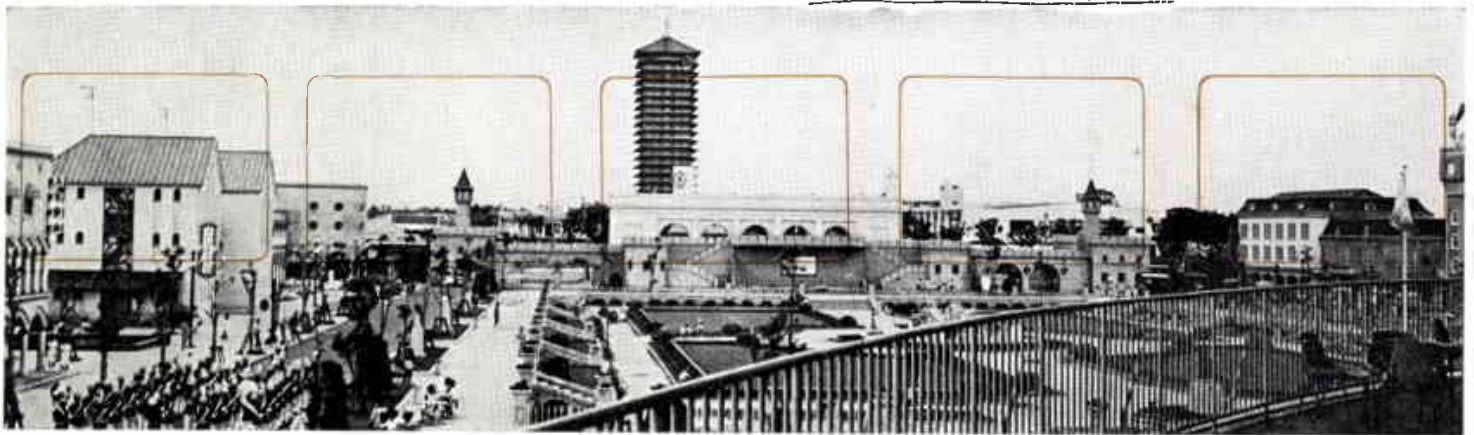

ACCESSORIES

58mm Close-Up Lenses 450 and 240

Close-up lenses are used when titling copying documents and when photographing plants and insects. 450 and 240 indicate the distance in millimeter from the tip of the lens to the subject when the distance scale of the close-up lenses are set at infinity.

◆ When using a close-up lens the depth-of-field

becomes shallow. Therefore, close the aperture down to smaller than $f/8$.

◆ Do not use a close-up lens at high magnification (telephoto), unless for special effects, because the depth-of-field becomes shallower.

◆ When the focal length is set at 60mm, you can obtain the same effect as that of attaching a close-up lens at a shooting distance of 1.2m.

Type	58mm Close-Up Lens 450				58mm Close-Up Lens 240			
	7.5mm		60mm		7.5mm		60mm	
Focal Length	∞		∞		∞		∞	
Distance Scale	∞	1.2m (4')	∞	1.2m (4')	∞	1.2m (4')	∞	1.2m (4')
Distance from Film Plane to Subject	609mm (2')	475mm (1'6 $\frac{3}{4}$ "	609mm (2')	475mm (1'6 $\frac{3}{4}$ "	394mm (1'3 $\frac{1}{2}$ "	353mm (1'1 $\frac{1}{8}$ "	394mm (1'3 $\frac{1}{2}$ "	353mm (1'1 $\frac{1}{8}$ "
Picture Area	339×251mm (1'11 $\frac{3}{8}$ "×9 $\frac{7}{8}$ "	224×166mm (8 $\frac{7}{8}$ "×6 $\frac{5}{8}$ "	45×33mm (1 $\frac{3}{4}$ "×1 $\frac{1}{8}$ "	30×22mm (1 $\frac{1}{8}$ "× $\frac{7}{8}$ "	179×132mm (7 $\frac{1}{8}$ "×5 $\frac{1}{4}$ "	138×102mm (5 $\frac{3}{8}$ "×4 $\frac{1}{8}$ "	24×17mm (1 $\frac{5}{8}$ "× $\frac{11}{8}$ "	18×13mm (1 $\frac{1}{4}$ "× $\frac{1}{2}$ "

Filters

The various 58mm screw-in type filters are available for the Canon Auto Zoom 814. Being a TTL

exposure system camera, any type of filter can be used without regard to the exposure factor.

Type	Filter Characteristics
● UV	Absorbs only ultra-violet rays. Especially effective at seaside and high mountains. Recommended for use in color photography.
○ Y1 ○ Y3	Increases contrast of monochrome film. Enhances clouds, darkening the blue sky. Brightens red and yellow.
○ O1	Darkens blue, increases yellow and red perceptibly. Good for contrasts, especially in distant landscapes.
○ R1	Makes strong contrasts. May also be used with infrared film.
○ G1	Prevents red from turning radically into white. Lightens faces and sky appropriately, and reflects the lightness of fresh greenery.
○ ND 4 ○ ND 8	ND 4 reduces light volume by 1/4, ND 8 by 1/8. No effects on the reproduction of colors of color film.
● SKYLIGHT	Acts to harmonize the blue sky and shade.
● CCA 4	For use with daylight type film under the cloud.
● CCA 8	For use with tungsten type film under the morning sun or sunset.
● CCB 4	For use with daylight type film under the morning sun or sunset.
● CCB (12equiv.)	For use with daylight type film under tungsten light.

○ For black and white film. ● For color film.